

DENON

AV SURROUND RECEIVER

AVR-1712

Owner's Manual

SAFETY PRECAUTIONS



CAUTION
RISK OF ELECTRIC SHOCK
DO NOT OPEN



CAUTION:
TO REDUCE THE RISK OF ELECTRIC SHOCK, DO NOT REMOVE COVER (OR BACK). NO USER-SERVICEABLE PARTS INSIDE. REFER SERVICING TO QUALIFIED SERVICE PERSONNEL.

The lightning flash with arrowhead symbol, within an equilateral triangle, is intended to alert the user to the presence of uninsulated "dangerous voltage" within the product's enclosure that may be of sufficient magnitude to constitute a risk of electric shock to persons.

The exclamation point within an equilateral triangle is intended to alert the user to the presence of important operating and maintenance (servicing) instructions in the literature accompanying the appliance.

WARNING:
TO REDUCE THE RISK OF FIRE OR ELECTRIC SHOCK, DO NOT EXPOSE THIS APPLIANCE TO RAIN OR MOISTURE.



Hot surface mark

CAUTION:
HOT SURFACE. DO NOT TOUCH.

The top surface over the internal heat sink may become hot when operating this product continuously. Do not touch hot areas, especially around the "Hot surface mark" and the top panel.

IMPORTANT SAFETY INSTRUCTIONS

1. Read these instructions.
2. Keep these instructions.
3. Heed all warnings.
4. Follow all instructions.
5. Do not use this apparatus near water.
6. Clean only with dry cloth.
7. Do not block any ventilation openings. Install in accordance with the manufacturer's instructions.
8. Do not install near any heat sources such as radiators, heat registers, stoves, or other apparatus (including amplifiers) that produce heat.
9. Do not defeat the safety purpose of the polarized or grounding-type plug. A polarized plug has two blades with one wider than the other. A grounding type plug has two blades and a third grounding prong. The wide blade or the third prong are provided for your safety. If the provided plug does not fit into your outlet, consult an electrician for replacement of the obsolete outlet.
10. Protect the power cord from being walked on or pinched particularly at plugs, convenience receptacles, and the point where they exit from the apparatus.
11. Only use attachments/accessories specified by the manufacturer.
12. Use only with the cart, stand, tripod, bracket, or table specified by the manufacturer, or sold with the apparatus. When a cart is used, use caution when moving the cart/apparatus combination to avoid injury from tip-over.
13. Unplug this apparatus during lightning storms or when unused for long periods of time.
14. Refer all servicing to qualified service personnel. Servicing is required when the apparatus has been damaged in any way, such as power-supply cord or plug is damaged, liquid has been spilled or objects have fallen into the apparatus, the apparatus has been exposed to rain or moisture, does not operate normally, or has been dropped.
15. Batteries shall not be exposed to excessive heat such as sunshine, fire or the like.



CAUTION:

To completely disconnect this product from the mains, disconnect the plug from the wall socket outlet.

The mains plug is used to completely interrupt the power supply to the unit and must be within easy access by the user.

FCC INFORMATION (For US customers)

1. PRODUCT

This product complies with Part 15 of the FCC Rules. Operation is subject to the following two conditions: (1) this product may not cause harmful interference, and (2) this product must accept any interference received, including interference that may cause undesired operation.

2. IMPORTANT NOTICE: DO NOT MODIFY THIS PRODUCT

This product, when installed as indicated in the instructions contained in this manual, meets FCC requirements. Modification not expressly approved by DENON may void your authority, granted by the FCC, to use the product.

3. NOTE

This product has been tested and found to comply with the limits for a Class B digital device, pursuant to Part 15 of the FCC Rules. These limits are designed to provide reasonable protection against harmful interference in a residential installation.

This product generates, uses and can radiate radio frequency energy and, if not installed and used in accordance with the instructions, may cause harmful interference to radio communications. However, there is no guarantee that interference will not occur in a particular installation. If this product does cause harmful interference to radio or television reception, which can be determined by turning the product OFF and ON, the user is encouraged to try to correct the interference by one or more of the following measures:

- Reorient or relocate the receiving antenna.
- Increase the separation between the equipment and receiver.
- Connect the product into an outlet on a circuit different from that to which the receiver is connected.
- Consult the local retailer authorized to distribute this type of product or an experienced radio/TV technician for help.

For Canadian customers:

This Class B digital apparatus complies with Canadian ICES-003.

❑ NOTES ON USE

WARNINGS

- Avoid high temperatures.
Allow for sufficient heat dispersion when installed in a rack.
- Handle the power cord carefully.
Hold the plug when unplugging the cord.
- Keep the unit free from moisture, water, and dust.
- Unplug the power cord when not using the unit for long periods of time.
- Do not obstruct the ventilation holes.
- Do not let foreign objects into the unit.
- Do not let insecticides, benzene, and thinner come in contact with the unit.
- Never disassemble or modify the unit in any way.
- Ventilation should not be impeded by covering the ventilation openings with items, such as newspapers, tablecloths or curtains.
- Naked flame sources such as lighted candles should not be placed on the unit.
- Observe and follow local regulations regarding battery disposal.
- Do not expose the unit to dripping or splashing fluids.
- Do not place objects filled with liquids, such as vases, on the unit.
- Do not handle the mains cord with wet hands.
- When the switch is in the OFF (STANDBY) position, the equipment is not completely switched off from MAINS.
- The equipment shall be installed near the power supply so that the power supply is easily accessible.

❑ CAUTIONS ON INSTALLATION

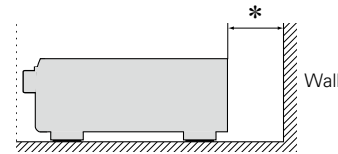
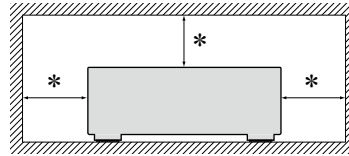

*** For proper heat dispersal, do not install this unit in a confined space, such as a bookcase or similar enclosure.**

- More than 12 in. (0.3 m) is recommended.
- Do not place any other equipment on this unit.

Getting started

Thank you for purchasing this DENON product. To ensure proper operation, please read this owner's manual carefully before using the product. After reading them, be sure to keep them for future reference.

Contents

Getting started	1
Accessories	1
Features	2
Cautions on handling	2

Basic version.....3

Connections	4
Important information	4
Connecting an HDMI-compatible device	6
Connecting a TV.....	8
Connecting a Blu-ray Disc player/DVD player	9
Connecting a set-top box (Satellite tuner/Cable TV)	9
Connecting a digital camcorder	10
Connecting a control dock for iPod.....	10
Connecting an antenna	11
Connecting a CD player	11
Connecting an external control device.....	12
Settings	13
Set up speakers (Audyssey® Auto Setup)	13
Playback (Basic operation)	20
Important information	20
Playing a Blu-ray Disc player/DVD player	21
Playing a CD player.....	21
Playing an iPod®.....	22
Tuning in radio stations.....	25
Selecting a listening mode (Surround mode)	27
Selecting a listening mode.....	27

Advanced version.....31

Speaker installation/connection (Advanced connection)	32
Install	32
Connect	34
Set up speakers.....	39
Playback (Advanced operation)	41
Convenient functions.....	41
Playback in ZONE2 (Separate room)	45
Audio output	45
Playback.....	45
Quick select function	46
Sleep timer function	46
How to make detailed settings	47
Menu map	47
Examples of menu screen displays	48
Examples of menu and front display	49
Inputting characters	50
Audio Adjust	52
Information	58
System Setup	59
Input Setup	68
Operating the connected devices by remote control unit	74
Operating AV devices	74
Registering preset codes.....	75
Operating devices.....	77
Specifying the zone used with the main remote control unit.....	79
Resetting the remote control unit.....	79

Information.....80

Part names and functions	81
Front panel.....	81
Display	82
Rear panel.....	83
Remote control unit.....	84
Other information	86
Trademark information.....	86
Surround	87
Relationship between video signals and monitor output.....	91
Explanation of terms.....	92
Troubleshooting	94
Resetting the microprocessor	96
Specifications	97

Accessories

Check that the following parts are supplied with the product.

① Getting Started	1
② CD-ROM (Owner's manual)	1
③ Warranty (for North America model only).....	1
④ Service network list.....	1
⑤ Remote control unit (RC-1156).....	1
⑥ R6/AA batteries	2
⑦ Setup microphone (DM-A409).....	1
⑧ AM loop antenna	1
⑨ FM indoor antenna	1

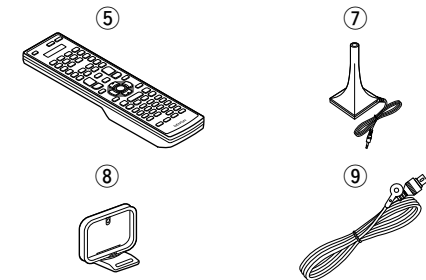

Features

Fully discrete, identical quality and power for all 7 channels (125 W x 7ch)

The unit is equipped with a power amplifier that reproduces high-fidelity sound in surround mode with equal quality and power for all channels, true to the original sound.

The power amplifier circuit adopts a discrete-circuit configuration that achieves high-quality surround sound reproduction.

Setup wizard, providing easy-to-follow setup instructions

First select the language when prompted. Then simply follow the instructions displayed on the TV screen to set up the speakers, etc.

Easy to use, Graphical User Interface

This unit is equipped with an easy to see "Graphical User Interface" that uses menu displays and levels. The use of level displays increases operability of the this unit.

Supports HDMI 1.4a with 3D, ARC, Deep Color, "x.v.Color", Auto Lip Sync and HDMI control function (👉 [page 6](#))

This unit can output 3D video signals input from a Blu-ray Disc player to a TV that supports a 3D system. This unit also supports the ARC (Audio Return Channel) function, which reproduces TV sound with this unit via an HDMI cable used for connecting the unit and a TV*.

* The TV should support the ARC function.

6-HDMI inputs and 1-output

The unit is equipped with 6 HDMI input connectors for connecting devices with HDMI connectors, such as a Blu-ray Disc player, game machine, HD video camera, etc.

High definition audio support

The unit is equipped with a decoder which supports high-quality digital audio format for Blu-ray Disc players such as Dolby TrueHD, DTS-HD Master Audio, etc.

Cautions on handling

• Before turning the power on

Check once again that all connections are correct and that there are no problems with the connection cables.

- Power is supplied to some of the circuitry even when the unit is set to the standby mode. When going on vacation or leaving home for long periods of time, be sure to unplug the power cord from the power outlet.

• About condensation

If there is a major difference in temperature between the inside of the unit and the surroundings, condensation (dew) may form on the operating parts inside the unit, causing the unit not to operate properly.

If this happens, let the unit sit for an hour or two with the power turned off and wait until there is little difference in temperature before using the unit.

• Cautions on using mobile phones

Using a mobile phone near this unit may result in noise. If that occurs, move the mobile phone away from this unit when it is in use.

• Moving the unit





Turn off the power and unplug the power cord from the power outlet. Next, disconnect the connection cables to other system units before moving the unit.

• About care



- Wipe the cabinet and control panel clean with a soft cloth.
- Follow the instructions when using a chemical cleaner.
- Benzene, paint thinner or other organic solvents as well as insecticide may cause material changes and discoloration if brought into contact with the unit, and should therefore not be used.

Basic version

Here, we explain the connections and basic operation methods for this unit.

- **Connections**  [page 4](#)
- **Settings**  [page 13](#)
- **Playback (Basic operation)**  [page 20](#)
- **Selecting a listening mode (Surround mode)**  [page 27](#)

	Connection	 page 7, 8
	Playback	–
	Connection	 page 7, 9
	Playback	 page 21
	Connection	 page 7, 9
	Playback	–
	Connection	 page 7
	Playback	–
	Connection	 page 11
	Playback	 page 25

	Connection	 page 7, 9
	Playback	 page 21
	Connection	 page 11
	Playback	 page 21
	Connection	 page 10
	Playback	 page 22
	Connection	 page 7, 10
	Playback	–

For speaker connections, see [page 34](#),  [page 6 "Connecting the speakers"](#).

Connections

Important information

- Make connections as follows before using this unit. Select an appropriate connection type according to the devices to be connected.
- You may need to make some settings on this unit depending on the connection method. Refer to each description for more information.
- Select the cables (sold separately) according to the devices being connected.

NOTE

- Do not plug in the power cord until all connections have been completed. (When the Setup wizard is running, follow the instructions in the Setup wizard screen for making connections.)
- When running the Setup wizard, turn off the power supply of connected devices.
- When making connections, also refer to the operating instructions of the other devices being connected.
- Be sure to connect the left and right channels properly (left with left, right with right).
- Do not bundle power cords together with connection cables. Doing so can result in noise.

Relationship between video signals and monitor output

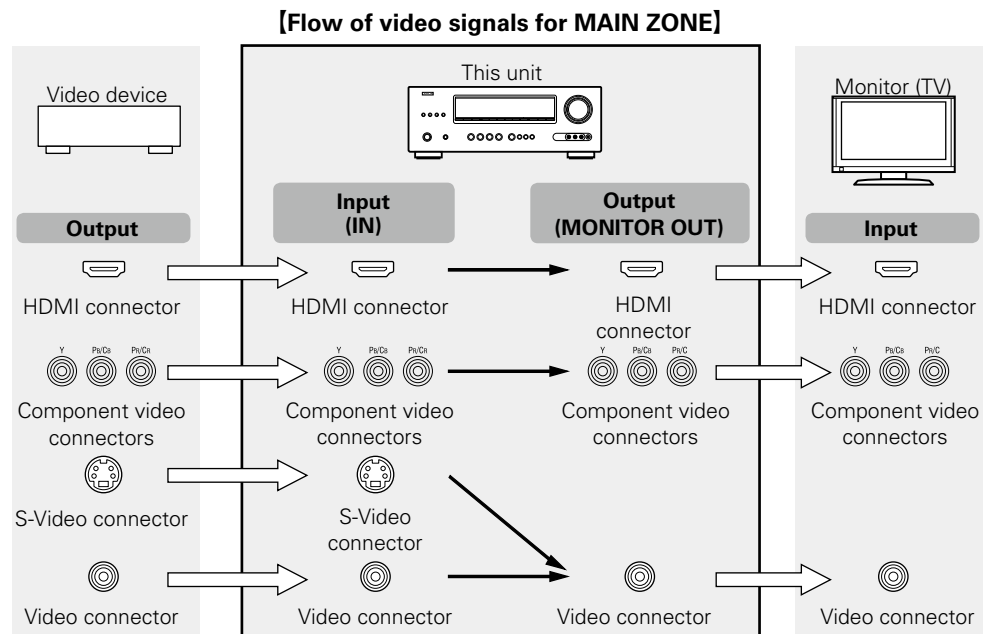

Resolutions of HDMI-compatible TVs can be checked at "HDMI Monitor Information" ([page 58](#)).

NOTE

- HDMI signals cannot be converted into analog signals ([page 91](#)).
- Analog signals cannot be converted into HDMI signals ([page 91](#)).

Examples of screen display

- Menu screen

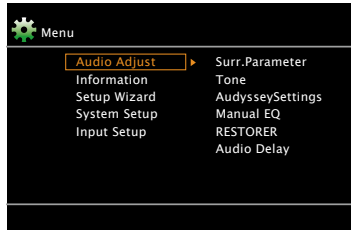

- Status display screen
When the input source is switched.

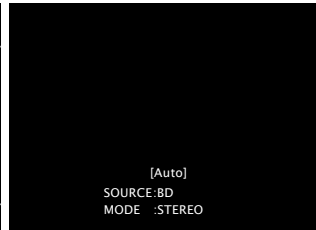

When the volume is adjusted.

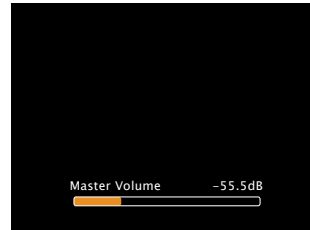

Status display: The operating status appears briefly on the screen when the input source is switched or the volume is changed.

NOTE

- If you operate the menu while playing back 3D video content or computer's resolution (e.g. VGA), the playback video is replaced by the menu screen. The playback video is not displayed behind the menu screen.
- This unit does not show the status display while playing back 3D video content or computer's resolution (e.g. VGA).
- The menu screen and status display are displayed when this unit and a TV are connected by HDMI. Furthermore, the menu screen and status display are not displayed when this unit and a TV are connected by VIDEO and COMPONENT VIDEO.

Connecting an HDMI-compatible device

You can connect up to seven HDMI-compatible devices (6-inputs/1-output) to the unit.

HDMI function

This unit supports the following HDMI functions:

- 3D
- Deep Color (🔗 [page 92](#))
- Auto Lip Sync (🔗 [page 63, 92](#))
- “x.v.Color”, sYCC601 color, Adobe RGB color, Adobe YCC601 color (🔗 [page 92, 93, 93](#))
- High definition digital audio format
- ARC (Audio Return Channel)
- Content Type
- CEC (HDMI control)

Copyright protection system

In order to play back digital video and audio such as BD-Video or DVD-Video via HDMI connection, both this unit and TV or the player need to support the copyright protection system known as HDCP (High-bandwidth Digital Content Protection System). HDCP is copyright protection technology comprised of data encryption and authentication of the connected AV devices. This unit supports HDCP.

- If a device that does not support HDCP is connected, video and audio are not output correctly. Read the owner’s manual of your television or player for more information.

About HDMI cables

- When a device supporting Deep Color is connected, use a cable compatible with “High Speed HDMI cable” or “High Speed HDMI cable with Ethernet”.
- When the ARC function is used, connect a device with a “Standard HDMI cable with Ethernet” or “High Speed HDMI cable with Ethernet” for HDMI 1.4a.

HDMI control function (🔗 [page 41](#))

This function allows you to operate external devices from the unit and operate the unit from external devices.

NOTE

- The HDMI control function may not work depending on the device it is connected to and its settings.
- You cannot operate a TV or Blu-ray Disc player/DVD player that is not compatible with the HDMI control function.

About 3D function

This unit supports input and output of 3D (3 dimensional) video signals of HDMI 1.4a.

To play back 3D video, you need a TV and player that provide support for the HDMI1.4a 3D function and a pair of 3D glasses.

NOTE

- When playing back 3D video, refer to the instructions provided in the manual of your playback device together with this manual.
- If you operate the menu while playing back 3D video content, the playback video is replaced by the menu screen. The playback video is not displayed behind the menu screen.
- This unit does not show the status display while playing back 3D video content.
- If 3D video with no 3D information is input, the menu screen and status display on this unit are displayed over the playback video.
- If 2D video is converted to 3D video on the television, the menu screen and status display on this unit are not displayed correctly. To view the menu screen and status display on this unit correctly, turn the television setting that converts 2D video to 3D video off.

About ARC (Audio Return Channel) function

The Audio Return Channel in HDMI 1.4a enables a TV, via a single HDMI cable, to send audio data “upstream” to this unit.

NOTE

- To enable the ARC function, set “HDMI Control” to “ON” (🔗 [page 63](#)).
- When connecting a TV that does not support the ARC function, a separate connection using an audio cable is required. In this case, refer to “Connecting a TV” (🔗 [page 8](#)) for the connection method.

About Content Type

HDMI 1.4a enables simple, automated picture setting selection with no user intervention.

NOTE

To enable the Content Type, set “Video Mode” to “Auto” (🔗 [page 71](#)).

Cables used for connections

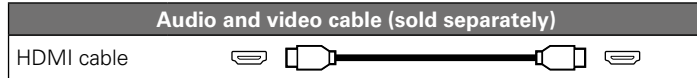

- This interface allows transfer of digital video signals and digital audio signals over a single HDMI cable.

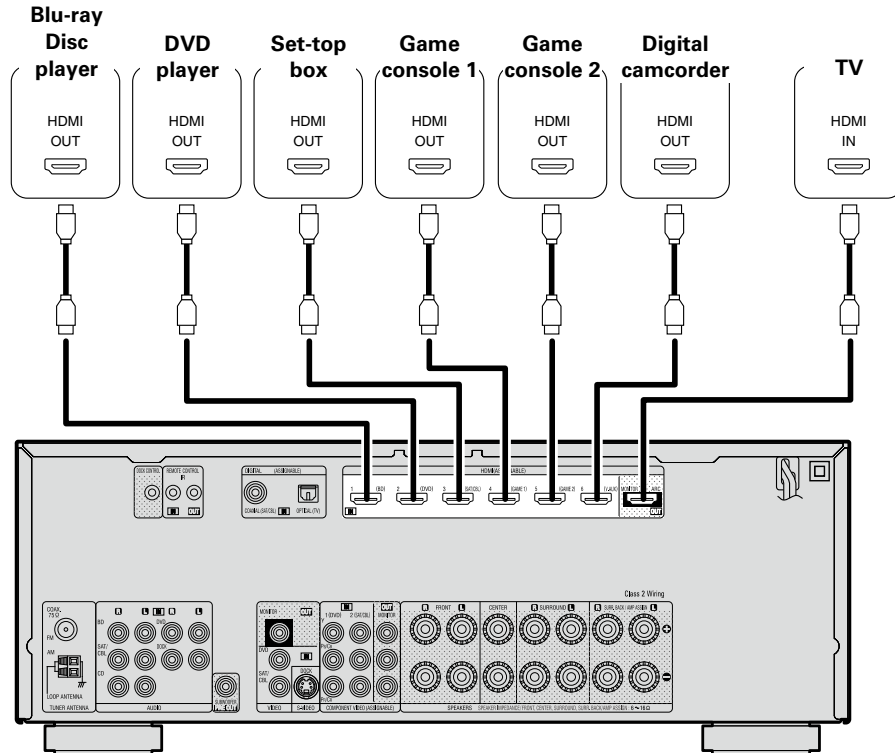

- When this unit is connected to other devices with HDMI cables, connect this unit and TV also with an HDMI cable.
- When connecting a device that supports Deep Color, please use a “High Speed HDMI cable” or “High Speed HDMI cable with Ethernet”.
- Video signals are not output if the input video signals do not match the monitor’s resolution. In this case, switch the Blu-ray Disc/DVD player’s resolution to a resolution with which the monitor is compatible.
- When this unit and monitor are connected with an HDMI cable, if the monitor is not compatible with HDMI audio signal playback, only the video signals are output to the monitor.

NOTE

The audio signal from the HDMI output connector (sampling frequency, number of channels, etc.) may be limited by the HDMI audio specifications of the connected device regarding permissible inputs.

Connecting to a device equipped with a DVI-D connector

When an HDMI/DVI conversion cable (sold separately) is used, the HDMI video signals are converted to DVI signals, allowing connection to a device equipped with a DVI-D connector.

NOTE

- No sound is output when connected to a device equipped with a DVI-D connector. Make separate audio connections.
- Signals cannot be output to DVI-D devices that do not support HDCP.
- Depending on the combination of devices, the video signals may not be output.

Settings related to HDMI connections

Set as necessary. For details, see the respective reference pages.

Input Assign (👉 page 70)

Set this to change the HDMI input connector to which the input source is assigned.

HDMI Setup (👉 page 63)

Make settings for HDMI video/audio output.

- Auto Lip Sync
- HDMI Audio Out
- Standby Source
- P.Off Control
- HDMI Control

NOTE

The audio signal input from the HDMI input connector can be output as an output signal from the HDMI output connector by setting the HDMI audio output destination to TV.

Audio signals input via the Analog/Coaxial/Optical input connectors cannot be output from the HDMI output connector.

Connecting a TV

- Select the connector to use and connect the device.
- For instructions on HDMI connections, see “Connecting an HDMI-compatible device” ([page 6](#)).



To listen to TV audio through this device, use the optical digital connection.

NOTE

The optical connection is not required when a TV compatible with the ARC function (Audio Return Channel HDMI 1.4a standard function) is connected to this unit via an HDMI connection. For details, see “About ARC (Audio Return Channel) function” ([page 6](#)) or refer to the instruction manual for your TV.

Cables used for connections

Video cable (sold separately)	
Video cable	
Component video cable	
Audio cable (sold separately)	
Optical cable	

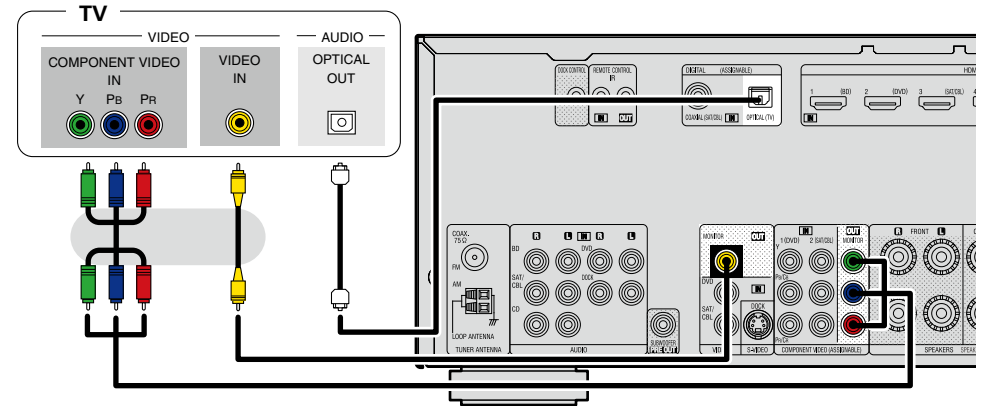

in Set as Necessary

Set this to change the digital input connector or component video input connector to which the input source is assigned.

“Input Assign” ([page 70](#))

Connecting a Blu-ray Disc player/DVD player

- You can enjoy video and audio from a Blu-ray Disc or DVD.
- Select the connector to use and connect the device.
- For instructions on HDMI connections, see “Connecting an HDMI-compatible device” ([page 6](#)).

Cables used for connections

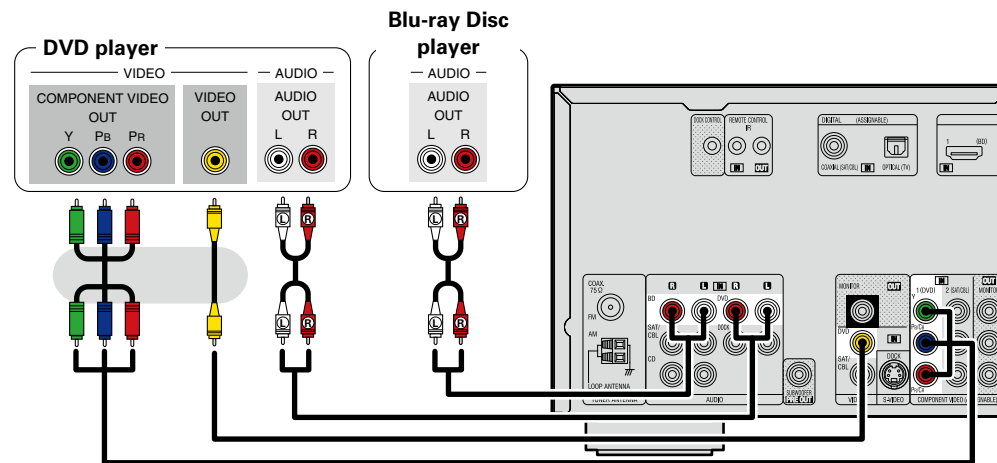
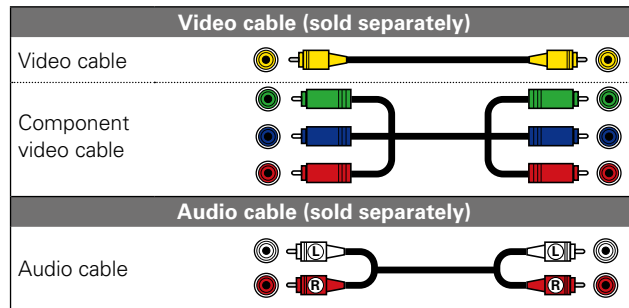

in Set as Necessary

Set this to change the digital input connector or component video input connector to which the input source is assigned.

“Input Assign” ([page 70](#))



When you want to play back HD Audio (Dolby TrueHD, DTS-HD, Dolby Digital Plus, DTS Express) and Multi-channel PCM with this unit, use an HDMI connection ([page 6](#) “Connecting an HDMI-compatible device”).

Connecting a set-top box (Satellite tuner/Cable TV)

- You can watch satellite or cable TV.
- Select the connector to use and connect the device.
- For instructions on HDMI connections, see “Connecting an HDMI-compatible device” ([page 6](#)).

Cables used for connections

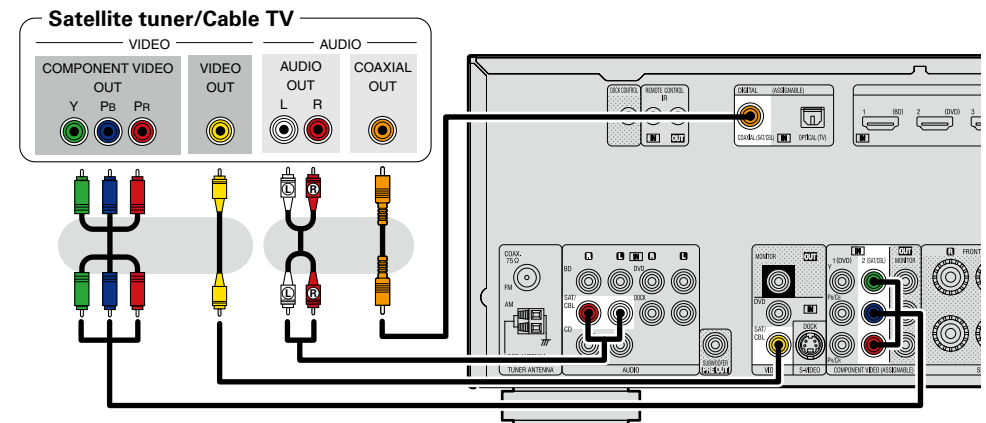
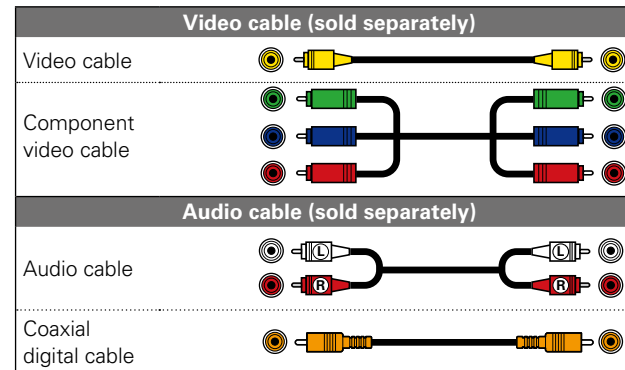

in Set as Necessary

Set this to change the digital input connector or component video input connector to which the input source is assigned.

“Input Assign” ([page 70](#))

Connecting a digital camcorder

- You can enjoy video and audio from a digital camcorder.
- For instructions on HDMI connections, see “Connecting an HDMI-compatible device” ([page 6](#)).

Cables used for connections

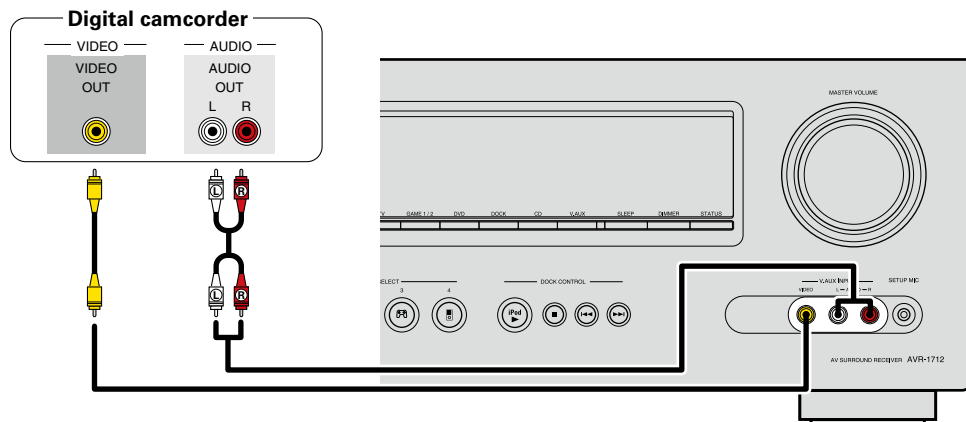
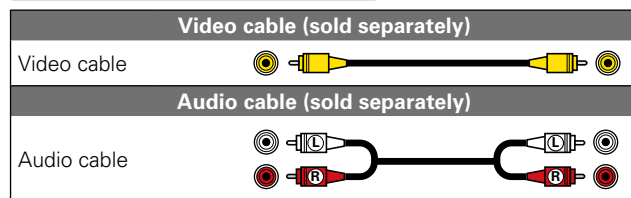

in Set as Necessary

Set this to change the digital input connector or component video input connector to which the input source is assigned.

“Input Assign” ([page 70](#))



You can enjoy games by connecting a game machine via the V.AUX input connector. In this case, select the input source to “V.AUX”.

Connecting a control dock for iPod

- Connect a control dock for iPod to the unit to enjoy video and music stored on an iPod.
- For a control dock for iPod, use ASD-1R, ASD-11R, ASD-3N, ASD-3W, ASD-51N or ASD-51W made by DENON (sold separately).
- For instructions on the control dock for iPod settings, refer to the control dock for iPod’s operating instructions.

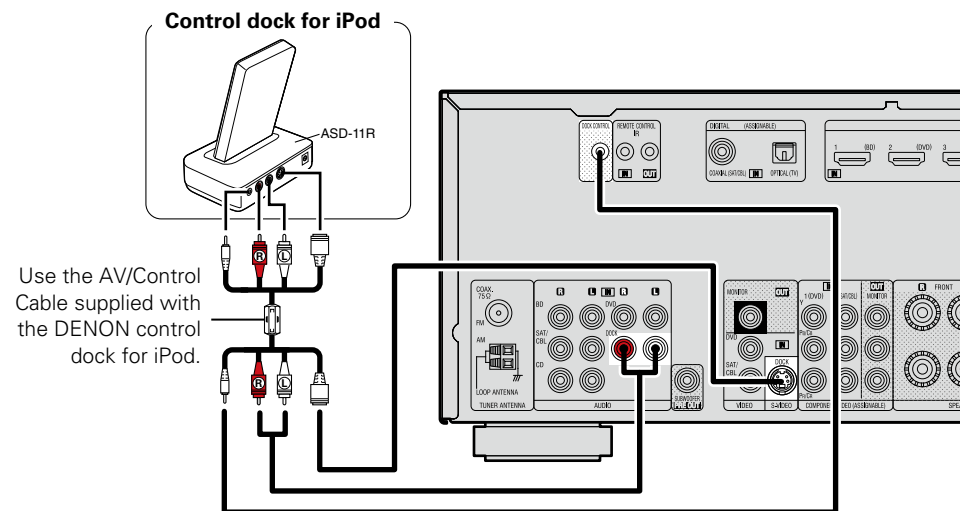

Connecting an antenna

- Connect the FM antenna or AM loop antenna supplied with the unit to enjoy listening to radio broadcasts.
- After connecting the antenna and receiving a broadcast signal (see [page 25](#) "Listening to FM/AM broadcasts"), fix the antenna with tape in a position where the noise level becomes minimal.

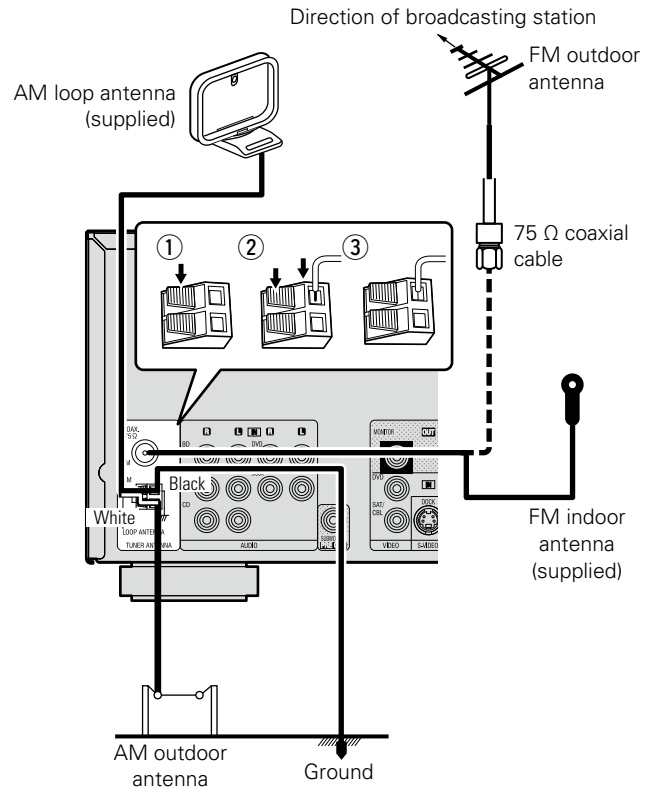

AM loop antenna assembly

- 1 Put the stand section through the bottom of the loop antenna from the rear and bend it forward.
- 2 Insert the projecting part into the square hole in the stand.

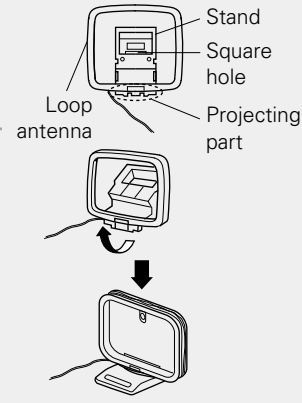

Using the AM loop antenna Suspending on a wall

Suspend directly on a wall without assembling.



Standing alone

Use the procedure shown above to assemble.

NOTE

- Do not connect two FM antennas simultaneously.
- Even if an external AM antenna is used, do not disconnect the AM loop antenna.
- Make sure the AM loop antenna lead terminals do not touch metal parts of the panel.
- If the signal has noise interference, connect the ground terminal (GND) to reduce noise.
- If you are unable to receive a good broadcast signal, we recommend installing an outdoor antenna. For details, inquire at the retail store where you purchased the unit.

Connecting a CD player

- You can enjoy CD sound.
- Select the connector to use and connect the device.

Cables used for connections

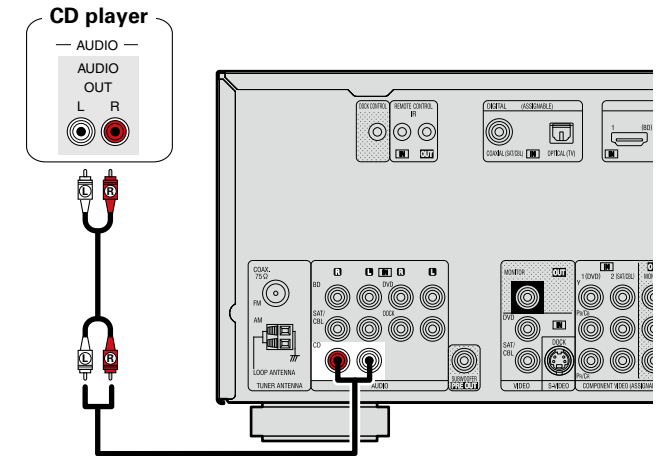
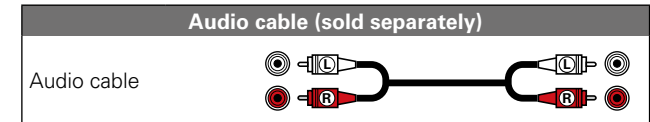

in Set as Necessary

Set this to change the digital input connector to which the input source is assigned.
"Input Assign" (see [page 70](#))

Connecting an external control device

REMOTE CONTROL jacks

If this unit is installed in a location that is out of range of the signal from the remote control unit, you can still operate the unit and the devices connected to it by using a commercially available IR receiver. You can also use it to remotely control ZONE2 (another room).

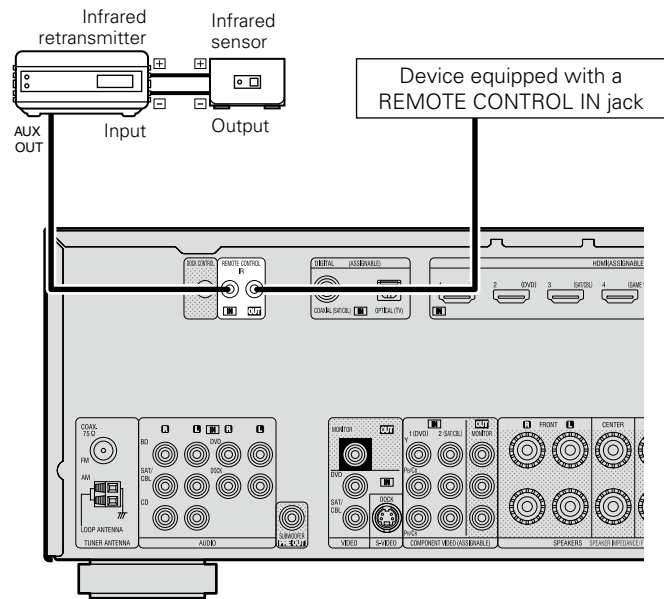

Settings

Here, we explain “Audyssey® Auto Setup”, which allows you to automatically make the optimal settings for your speakers.

□ Set up speakers (Audyssey® Auto Setup)

(👉 page 13)

Playback (Basic operation) (👉 page 20)

Selecting a listening mode (Surround mode)

(👉 page 27)

Playback (Advanced operation) (👉 page 41)



Set up speakers (Audyssey® Auto Setup)



The acoustic characteristics of the connected speakers and listening room are measured and the optimum settings are made automatically. This is called “Audyssey® Auto Setup”.

To perform measurement, place the setup microphone in multiple locations all around the listening area. For best results, we recommend you measure in six or more positions, as shown in the illustration (up to eight positions).

- When performing Audyssey® Auto Setup, Audyssey MultEQ® XT/Audyssey Dynamic EQ®/Audyssey Dynamic Volume® functions become active (👉 page 55, 56).
- To set up the speakers manually, use “Speaker Setup” (👉 page 60) on the menu.

NOTE

- Make the room as quiet as possible. Background noise can disrupt the room measurements. Close windows, silence cell phones, televisions, radios, air conditioners, fluorescent lights, home appliances, light dimmers, or other devices as measurements may be affected by these sounds.
- Cell phones should be placed away from all audio electronics during the measurement process as Radio Frequency Interference (RFI) may cause measurement disruptions (even if the cell phone is not in use).
- Do not unplug the setup microphone from the main unit until Audyssey® Auto Setup is completed.
- Do not stand between the speakers and setup microphone or allow obstacles in the path while the measurements are being made. This will cause inaccurate readings.
- Loud test sounds may be played during Audyssey® Auto setup. This is part of normal operation. If there is background noise in room, these test signals will increase in volume.
- Operating (🔊)▲▼ during the measurements will cancel the measurements.
- Measurement cannot be performed when headphones are connected.



About setup microphone placement

- Measurements are performed by placing the setup microphone successively at multiple positions throughout the entire listening area, as shown in [Example ①]. For best results, we recommend you measure in six or more positions, as shown in the illustration (up to eight positions).
- Even if the listening environment is small as shown in [Example ②], measuring at multiple points throughout the listening environment results in more effective correction.

[Example ①]

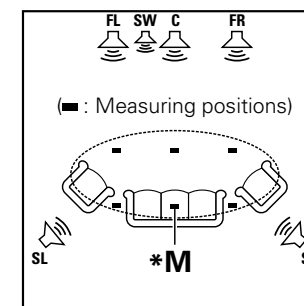

[Example ②]

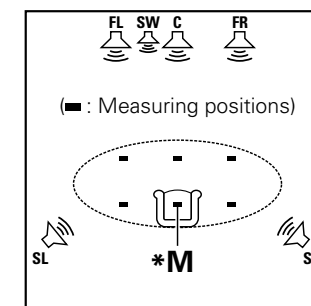

FL Front speaker (L)
FR Front speaker (R)
C Center speaker

SW Subwoofer
SL Surround speaker (L)
SR Surround speaker (R)

About the main listening position (*M)

The main listening position is the position where listeners would normally sit or where one would normally sit alone within the listening environment. Before starting Audyssey® Auto Setup, place the setup microphone in the main listening position. Audyssey MultEQ® XT uses the measurements from this position to calculate speaker distance, level, polarity, and the optimum crossover value for the subwoofer.

1 Set up the microphone

Mount the setup microphone on a tripod or stand and place it in the main listening position.

When placing the setup microphone, adjust the height of the sound receptor to the level of the listener's ear.

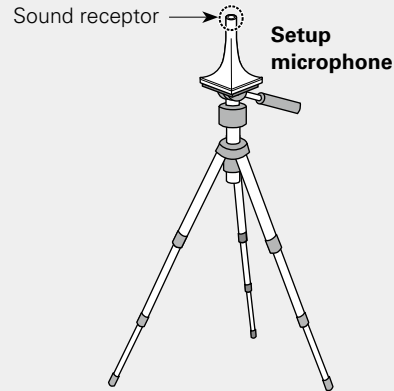

If you do not have a tripod or stand, set up the microphone on, for example, a seat without a back.

NOTE

- Do not hold the setup microphone in your hand during measurements.
- Avoid placing the setup microphone close to a seat back or wall as sound reflections may give inaccurate results.

2 Set up the subwoofer

If using a subwoofer capable of the following adjustments, set up the subwoofer as shown below.

- ❑ **When using a subwoofer with a direct mode**
Set the direct mode to "On" and disable the volume adjustment and crossover frequency setting.
- ❑ **When using a subwoofer without a direct mode**
Make the following settings:
 - **Volume** : "12 o'clock position"
 - **Crossover frequency** : "Maximum/Highest Frequency"
 - **Low pass filter** : "Off"
 - **Standby mode** : "Off"

3 Set up the remote control unit

- ❑ **Set up the zone mode**
Press **ZONE SELECT** to switch the zone mode to **M (MAIN ZONE)**.
The **M** indicator lights.

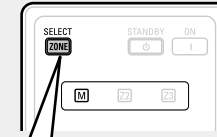

Press ZONE SELECT

- ❑ **Set up the operation mode**
Press **AMP** to set the remote control unit to AMP-operation mode.

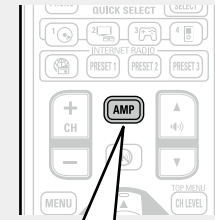

Press AMP

STEP 1 Preparation

4 Connect the setup microphone to the SETUP MIC jack of this unit.

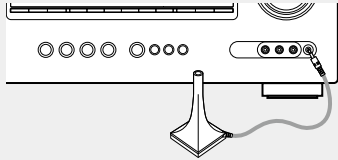

When the setup microphone is connected, the following screen is displayed.

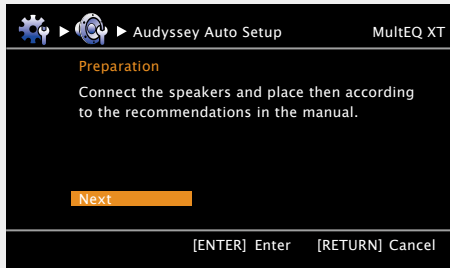

5 Select “Next” and then press ENTER.

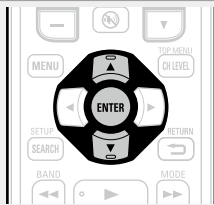

STEP 2 Detect & Measure (Main)

6 Use Δ / ∇ to select “Auto Setup Start” and then press ENTER.

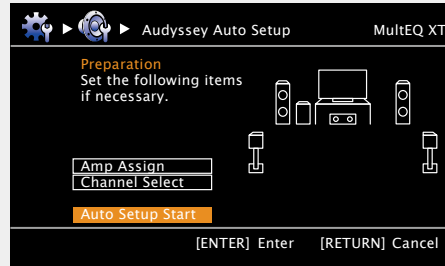

Here, we explain setup using the example of 5.1-channel speaker playback.

For settings other than 5.1-channel surround, select “Amp Assign” and perform step 4 to 5 of “Set up “Amp Assign”” (page 39). If unused channels are set with “Channel Select”, measuring time can be shortened. For setting, perform steps 7 to 11 of “Set up “Channel Select”” (page 40).

- In STEP 2, you will perform measurements at the main listening position.
- This step automatically checks the speaker configuration and speaker size, and calculates the channel level, distance, and crossover frequency.

It also corrects distortion in the listening area.

7 Select “Measure” and then press ENTER.

When measuring begins, a test tone is output from each speaker.

- Measurement requires several minutes.

8 The detected speakers are displayed.

- The illustration below shows an example of when the front speakers, center speaker, subwoofer, and surround speakers have been detected.

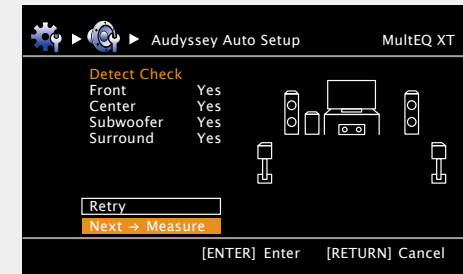

NOTE

If a connected speaker is not displayed, the speaker may not be connected correctly. Check the speaker connection.

9 Use Δ / ∇ to select “Next → Measure” and then press ENTER.

STEP 2 (Continued) Detect & Measure (Main)

NOTE

If "Caution" is displayed:

Go to "Error messages" (page 18), check any related items, and perform the necessary procedures.
If the problem is resolved, return and restart "Audyssey® Auto Setup".

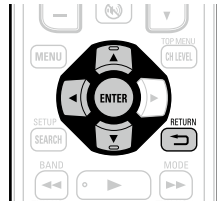

When performing Audyssey® Auto Setup over again

Press $\Delta \nabla$ to select "Retry", and then press **ENTER**.

When measuring has stopped

- ① Press **RETURN** \leftarrow , to the "Cancel Auto Setup?" prompt is displayed.
- ② Press \leftarrow to select "Yes", then press **ENTER**.

Setting up the speakers again

Repeat the operation from step 4 of **STEP 1 Preparation**.

STEP 3 Measure (2nd – 8th)

- In STEP 3, you will perform measurements at multiple positions (two to eight positions) other than the main listening position.
- Just one position can be measured but measuring multiple positions increases the accuracy of the correction of acoustic distortion within the listening area.

10 Move the setup microphone to position 2, use $\Delta \nabla$ to select "Measure", and then press **ENTER**.

The measurement of the second position starts. Measurements can be made in up to eight positions.

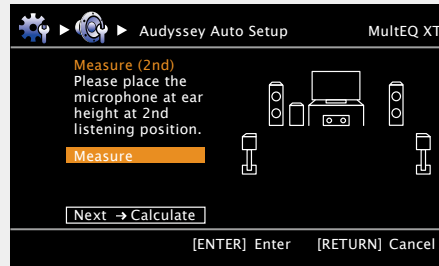
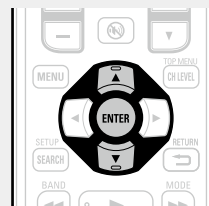

If you want to omit measurements from the next position onward, select "Next \rightarrow Calculate".
(Go to **STEP4 Calculate**)

11 Repeat step 10, measuring positions 3 to 8.

When measurement of position 8 is completed, a "Measurements finished." message is displayed.

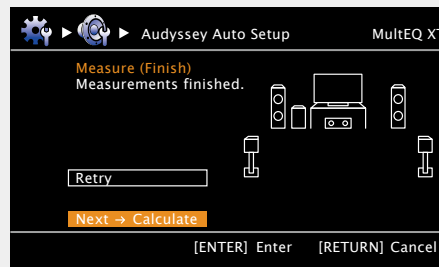

STEP 4 Calculate

12 On the **STEP 3** screen, use $\Delta \nabla$ to select "Next \rightarrow Calculate", and then press **ENTER**.

Measuring results are analyzed, and the frequency response of each speaker in the listening room is determined.

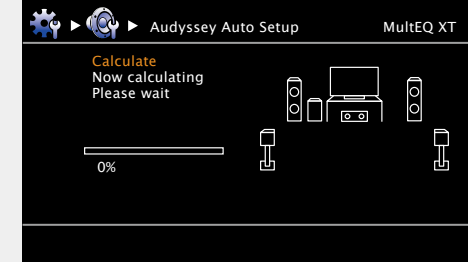

- Analysis takes several minutes to complete. The time required for this analysis depends on the number of speakers connected. The more connected speakers there are, the longer it takes to perform analysis.

STEP 5 Check

13 Use Δ / ∇ to select the item you want to check, and then press **ENTER**.

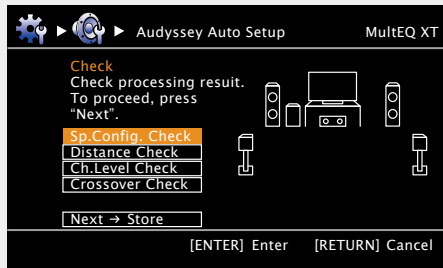
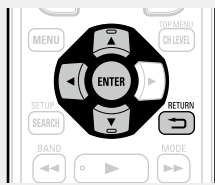

- Subwoofers may measure a greater reported distance than the actual distance due to added electrical delay common in subwoofers.
- If you want to check another item, press **RETURN** \leftarrow .

14 Use Δ / ∇ to select “Next \rightarrow Store” and then press **ENTER**.

NOTE

- If the result differs from the actual connection status, or if “Caution!” is displayed, see “Error messages” ([page 18](#)). Then carry out Audyssey® Auto Setup again.
- If you change speaker positions or orientation, perform Audyssey® Auto Setup again to find the optimal equalizer settings.

STEP 6 Store

15 Select “Store” and then press **ENTER**.
Save the measurement results.

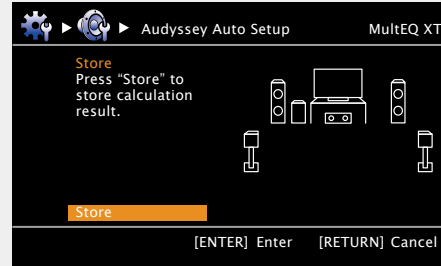

- Saving the results requires about 10 seconds.
- If the measuring results are not to be saved, press **RETURN** \leftarrow . A message “Cancel Auto Setup?” will be displayed. Press \leftarrow then select “Yes”. All the measured Audyssey® Auto Setup data will be erased.
- During saving of measurements results, “Now storing Please wait...” is displayed. When saving is completed, “Storing complete. Auto Setup is now finished.” is displayed.

NOTE

During saving of measurement results, be sure not to turn off the power.

Finish

16 Unplug the setup microphone from the unit’s **SETUP MIC** jack.

17 Set Audyssey Dynamic Volume®.

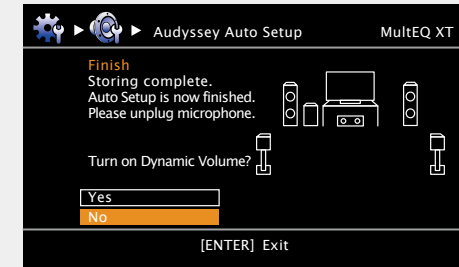

- This feature adjusts the output volume to the optimal level while constantly monitoring the level of the audio input to the unit. Optimal volume control is performed automatically without any loss in the dynamism and clarity of the sound when, for example, the volume suddenly increases for commercials shown during television programs.

□ When turning Dynamic Volume® on

- Use Δ to select “Yes”, and then press **ENTER**. The unit automatically enters “Evening” mode.

□ When turning Dynamic Volume® off

- Use ∇ to select “No”, and then press **ENTER**.

NOTE

After performing Audyssey® Auto Setup, do not change the speaker connections or subwoofer volume. In event of a change, perform Audyssey® Auto Setup again.

Error messages

NOTE

- An error message is displayed if Audyssey® Auto Setup could not be completed due to speaker placement, the measurement environment, etc. If this happens, check the relevant items, be sure to take the necessary measures, then perform Audyssey® Auto Setup over again.
- If the result still differs from the actual connection status after remeasurement or the error message still appears, it is possible that the speakers are not connected properly. Turn this unit off, check the speaker connections and repeat the measurement process from the beginning.
- Be sure to turn off the power before checking speaker connections.

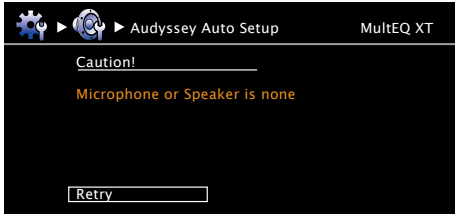
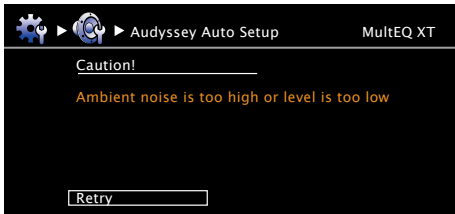
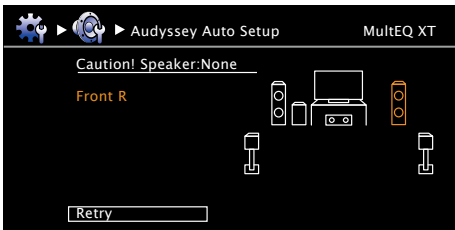
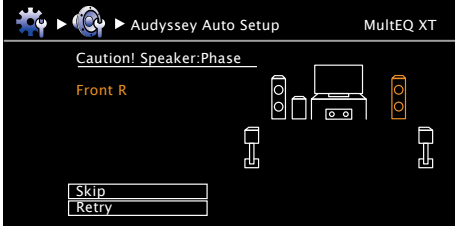
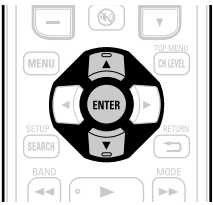
Examples	Error details	Measures
	<ul style="list-style-type: none"> • The connected setup microphone is broken, or a device other than the supplied setup microphone is connected. • Not all speakers could be detected. • The front L speaker was not properly detected. 	<ul style="list-style-type: none"> • Connect the included setup microphone to the SETUP MIC jack of this unit. • Check the speaker connections.
	<ul style="list-style-type: none"> • There is too much noise in the room for accurate measurements to be made. • Speaker or subwoofer sound is too low for accurate measurements to be made. 	<ul style="list-style-type: none"> • Either turn off any device generating noise or move it away. • Perform again when the surroundings are quieter. • Check the speaker installation and the direction in which the speakers are facing. • Adjust the subwoofer's volume.
	<ul style="list-style-type: none"> • The displayed speaker could not be detected. (The screen on the left indicates that the front right speaker cannot be detected.) 	<ul style="list-style-type: none"> • Check the connections of the displayed speaker.
	<ul style="list-style-type: none"> • The displayed speaker is connected with the polarity reversed. (The screen on the left indicates that the polarity phases of the front right speakers are reversed.) 	<ul style="list-style-type: none"> • Check the polarity of the displayed speaker. • For some speakers, this error message may be displayed even if the speaker is properly connected. If you are sure the connection is correct, press Δ/∇ to select "Skip", then press ENTER. 

Parameter Check

This function enables you to check the measurement results and equalizer characteristics after Audyssey® Auto Setup.

1 Use Δ / ∇ to select “Parameter Check” and then press **ENTER**.

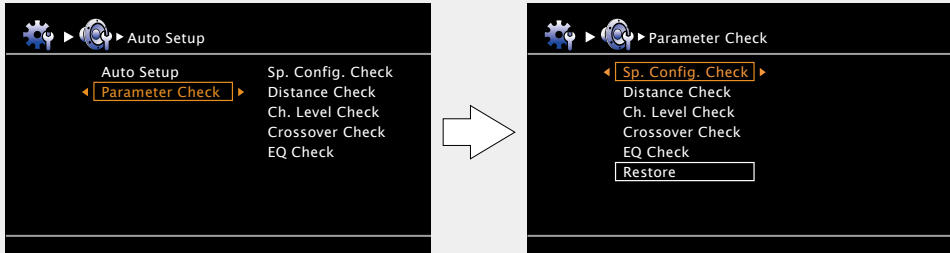

2 Use Δ / ∇ to select the item you want to check, then press **ENTER** or \triangleright .

Measurement results for each speaker are displayed.

- Sp. Config. Check** Check the speaker configuration.
- Distance Check** Check the distance.
- Ch. Level Check** Check the channel level.
- Crossover Check** Check the crossover frequency.
- EQ Check** Check the equalizer.

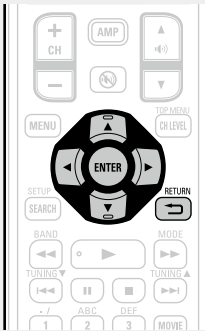

- If “EQ Check” is selected, press Δ / ∇ to select equalizing curve (“Audyssey” or “Audyssey Flat”) to be checked.
Use \triangleleft / \triangleright to switch the display between the different speakers.

3 Press **RETURN** \curvearrowright .

The confirmation screen reappears. Repeat step 2.

Retrieving Audyssey® Auto Setup settings

If you set “Restore” to “Yes”, you can return to Audyssey® Auto Setup measurement result (value calculated at the start by MultEQ® XT) even when you have changed each setting manually.

Playback (Basic operation)

Settings (page 13)

- ❑ **Selecting the input source** (page 20)
- ❑ **Adjusting the master volume** (page 21)
- ❑ **Turning off the sound temporarily** (page 21)

- ❑ **Playing a Blu-ray Disc player/DVD player** (page 21)
- ❑ **Playing a CD player** (page 21)
- ❑ **Playing an iPod®** (page 22)
- ❑ **Tuning in radio stations** (page 25)

Selecting a listening mode (Surround mode) (page 27)

Playback (Advanced operation) (page 41)

Important information

Before starting playback, make the connections between the different devices and the settings on the unit.

NOTE

Also refer to the operating instructions of the connected devices when playing them.

Selecting the input source

Press the input source select button (**BD, SAT/CBL, TV, DVD, V.AUX, DOCK, TUNER, GAME1, GAME2 or CD**) to be played back.

The desired input source can be selected directly.

- If the input source select button (**TUNER, BD, SAT/CBL, TV, GAME 1/2, DVD, DOCK, CD, V.AUX**) on the main unit is pressed, the same function as with the remote control unit can be obtained.
- When **iPod ▶** on the main unit is pressed, the input source of this unit is switched to "DOCK" and the connected iPod is automatically played (page 24 "iPod play function").

You can also use the following operation to select an input source.

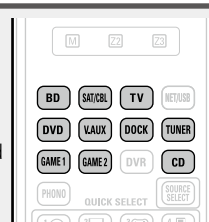

❑ Using the "Source Select" menu

Switch the remote control unit to the **[M]** (MAIN ZONE) mode when performing this operation (page 74 "Operating AV devices"). If the remote control unit is in **[Z2]** (ZONE2) mode, the "Source Select" menu will not be displayed when **SOURCE SELECT** is pressed.

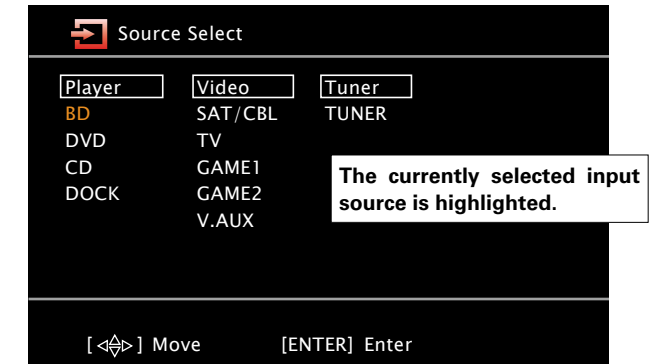

- ① Press **SOURCE SELECT**.
Display the "Source Select" menu.
- ② Use **Δ▽◀▶** to select the input source, then press **ENTER**.
The input source is set and the source selection menu is turned off.

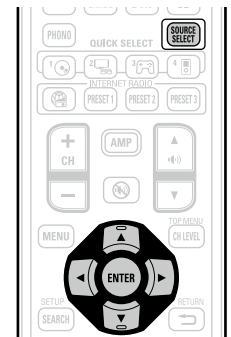

- Input sources that are not going to be used can be set ahead of time. Make this setting at "Source Delete" (page 65).
- To turn off the source selection menu without selecting an input source, press **SOURCE SELECT** again.
- When **SOURCE SELECT** is pressed, the AMP-operation mode starts automatically (page 74).

Adjusting the master volume

Use **▲▼** to adjust the volume.

- When the "Volume Display" setting ([page 65](#)) is "Relative" [Adjustable range]

--- -80.5dB - 18.0dB

- When the "Volume Display" setting ([page 65](#)) is "Absolute"

[Adjustable range] 0.0 - 99.0

- The variable range differs according to the input signal and channel level setting.



You can also operate via the main unit. In this case, perform the following operations.

Turn **MASTER VOLUME** to adjust the volume.

Turning off the sound temporarily

Press .

- The power indicator flashes green.
- "MUTE" indicator on the display lights.
- appears on a TV screen.



- The sound is reduced to the level set at "Mute Level" ([page 65](#)).
- To cancel, press again. Muting can also be canceled by adjusting the master volume.

Playing a Blu-ray Disc player/DVD player

The following describes the procedure for playing Blu-ray Disc player/DVD player.

1 Prepare for playback.

- Turn on the power of the TV, subwoofer and player.
- Change the TV input to the input of this unit.
- Load the disc in the player.

2 Press ON to turn on power to the unit.

3 Press BD or DVD to switch an input source for a player used for playback.

4 Play the device connected to this unit.

- Make the necessary settings on the player (language setting, subtitles setting, etc.) beforehand.

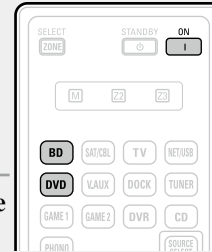

Playing a CD player

The following describes the procedure for playing CD player.

1 Prepare for playback.

- Turn on the power of the subwoofer and player.
- Load the disc in the player.

2 Press ON to turn on power to the unit.

3 Press CD to switch the input source to the CD player.

4 Play the device connected to this unit.

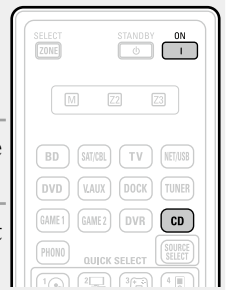

Playing an iPod®

If you use a separately sold DENON control dock for iPod (ASD-1R, ASD-11R, ASD-3N, ASD-3W, ASD-51N or ASD-51W), you will be able to play back videos, photos, music, and other content on the iPod. The playback method differs depending on the control dock for iPod to be used and the files to be played back (music or video).

Listening to music on an iPod

1 Prepare for playback.

- Connect the DENON control dock for iPod to this unit (page 10 "Connecting a control dock for iPod").
- Set the iPod in the DENON control dock for iPod.

2 Press ON to turn on power to the unit.

3 Press DOCK to switch the input source to "DOCK".

- If "Browse mode" is selected in step 4, the following screen is displayed on a TV screen, depending on the connected control dock for iPod.

(When using an ASD-1R)

(When using an ASD-11R)

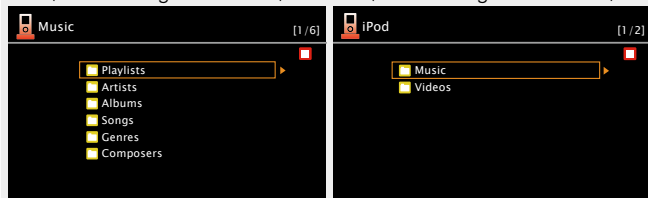

[When using an ASD-3N, ASD-3W, ASD-51N and ASD-51W]

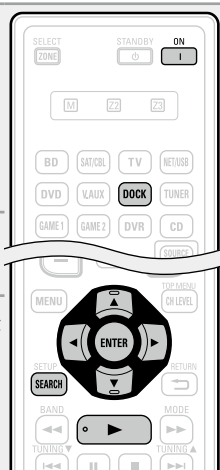
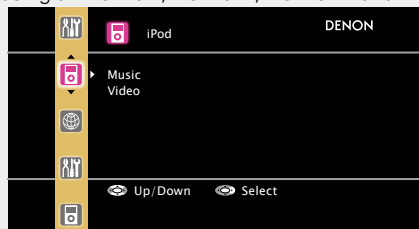

- In "Browse mode", the iPod display is as shown at right.

NOTE

If the connections screen is not displayed, the iPod may not be properly connected. Reconnect it.

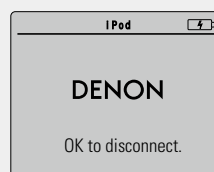

4 Press SEARCH and hold it down for 2 seconds or more to select the display mode.

- There are two modes for displaying the contents recorded on the iPod.

Browse mode Display iPod information on the TV screen.

- English letters, numbers and certain symbols are displayed. Incompatible characters are displayed as "." (period).

Remote mode Display iPod information on the iPod screen.

- "Remote iPod" is displayed on the display of this unit.

Display mode		Browse mode	Remote mode
Playable files	Music file	✓	✓
	Photo file		✓ *2
	Video file	✓ *1	✓ *2
Active buttons	Remote control unit (This unit)	✓	✓
	iPod		✓

*1 When using an ASD-11R, ASD-3N, ASD-3W, ASD-51N or ASD-51W DENON control dock for iPod.

*2 Video may not be output, depending on the combination of ASD-1R, ASD-11R, ASD-3N, ASD-3W, ASD-51N or ASD-51W DENON control dock for iPod and iPod.

5 Use Δ ∇ to select the item, then press ENTER or \triangleright to select the file to be played.

6 Press ENTER, \triangleright or \blacktriangleright . Playback starts.



- You can specify the duration of the on-screen display to be displayed (default: 30 sec) at menu "iPod" (page 66). Press Δ ∇ \triangleleft \triangleright to return to the original screen.
- To play back compressed audio with extended bass or treble reproduction, we recommend playback in RESTORER mode (page 57). The default setting is "Mode3".
- In Browse mode, press **STATUS** on the main unit during playback to check the title name, artist name, and album name on the display of this unit.

NOTE

- Press **STANDBY** and set this unit's power to the standby mode before disconnecting the iPod. You can also switch the input source to other than "DOCK" and then disconnect the iPod.
- Depending on the type of iPod and the software version, some functions may not operate.
- Note that DENON will accept no responsibility whatsoever for any problems arising with the data on an iPod when using this unit in conjunction with the iPod.

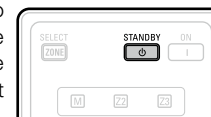

* iPod is a trademarks of Apple Inc., registered in the U.S. and other countries.

❑ Viewing videos on an iPod in the Browse mode

When an iPod equipped with a video function is connected to a DENON ASD-11R, ASD-3N, ASD-3W, ASD-51N and ASD-51W control dock for iPod, image files can be played in the Browse mode.

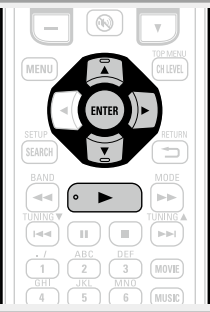
1	Use $\Delta \nabla$ to select “Videos”, then press ENTER or \triangleright .	
2	Use $\Delta \nabla$ to select the search item or folder, then press ENTER or \triangleright .	
3	Use $\Delta \nabla$ to select the video file, then press ENTER , \triangleright or \blacktriangleright . Playback starts.	

❑ Viewing photos and videos on an iPod in the Remote mode

This unit can play back on a TV screen photos and data stored on an iPod equipped with a slide show or video function.

1	Press and hold SEARCH to set the Remote mode. “Remote iPod” is displayed on the display of this unit.	
2	Watching the iPod’s screen, use $\Delta \nabla$ to select “Photos” or “Videos”.	
3	Press ENTER until the image you want to view is displayed.	



“TV Out” at the iPod’s “Slide show Settings” or “Video Settings” must be set to “On” in order to display the iPod’s photo data or videos on the monitor. For details, see the iPod’s operating instructions.

NOTE

Video may not be output, depending on the combination of ASD-1R, ASD-11R, ASD-3N, ASD-3W, ASD-51N or ASD-51W and iPod.

❑ iPod operation



Operation buttons	Function
MENU	Amp menu
$\Delta \nabla \triangleleft \triangleright$	Cursor operation / Auto search (cue, $\Delta \nabla$) / Manual search (Press and hold, $\Delta \nabla$)
ENTER (Press and release)	Enter / Pause
ENTER (Press and hold)	Stop
SEARCH (Press and release)	Page search mode* (for ASD-1R, ASD-11R)
SEARCH (Press and hold)	Browse / Remote mode switching
RETURN	Return
$\triangleleft \triangleleft \triangleright \triangleright$ (Press and hold)	Manual search (fast-reverse/fast-forward)
\blacktriangleright	Playback / Pause
$\blacktriangleleft \blacktriangleright$	Auto search (cue)
II	Pause
■	Stop
TV I / ⏻	TV power on/standby (Default : SONY)
TV INPUT	Switch TV input (Default : SONY)

- Repeat playback (☞ page 73 “Repeat”)
- Shuffling playback (☞ page 73 “Shuffle”)

* When the menu screen is displayed, press **SEARCH**, then press \triangleleft (previous page) or \triangleright (next page).
To cancel, press $\Delta \nabla$ or **SEARCH**.

iPod play function

If **iPod ▶** on the main unit is pressed when a control dock for iPod is connected, the iPod starts playback.

Press iPod ▶.

- This unit's input source switches to "DOCK".
- iPod playback starts.

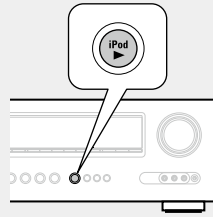

Tuning in radio stations

Listening to FM/AM broadcasts

1 Press **TUNER** to switch the input source to “TUNER”.

2 Press **BAND** to select “FM” or “AM”.

FM When listening to an FM broadcast.

AM When listening to an AM broadcast.

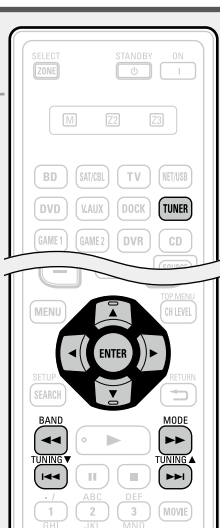
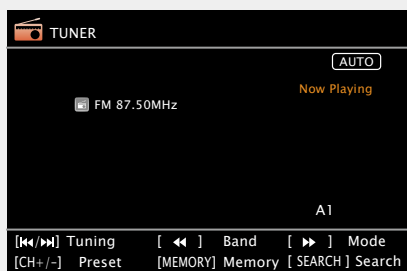

3 Tune in the desired broadcast station.

① To tune in automatically (Auto tuning)

Press **MODE** to light the “AUTO” indicator on the display, then use **TUNING ▲** or **TUNING ▼** to select the station you want to hear.

② To tune in manually (Manual tuning)

Press **MODE** to turn off the display’s “AUTO” indicator, then use **TUNING ▲** or **TUNING ▼** to select the station you want to hear.



- If the desired station cannot be tuned in with auto tuning, tune it in manually.
- When tuning in stations manually, press and hold **TUNING ▲** or **TUNING ▼** to change frequencies continuously.
- The time (default : 30 sec) for which the menu are displayed can be set at menu “Tuner” (page 66). Press **△▽◀▶** to return to the original screen.

❑ Presetting radio stations (Manual preset)

Your favorite broadcast stations can be preset so that you can tune them in easily. Up to 56 stations can be preset.

- Stations can be preset automatically at “Auto Preset” (page 69). If “Auto Preset” is performed after performing “Manual preset”, the “Manual preset” settings will be overwritten.

1 Tune in the broadcast station you want to preset.

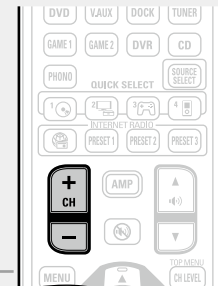
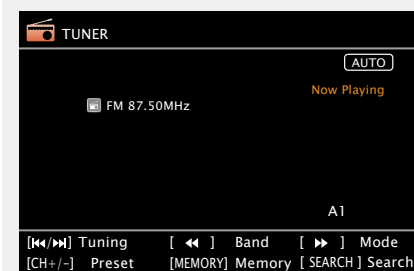

2 Press **MEMORY**.

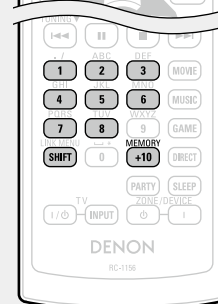
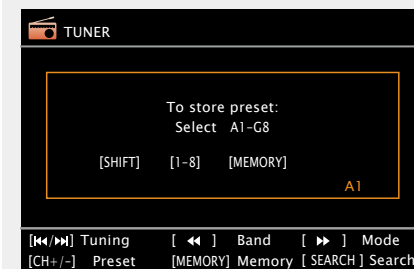

3 Press **SHIFT** to select the block (A to G) in which the channel (1 to 8 per a block) is to be preset, then press **CH +**, **CH –** or **1 – 8** to select the preset number.

4 Press **MEMORY** again to complete the setting.

- To preset other stations, repeat steps 1 to 4.

Default settings

Block (A – G) and Channel (1 – 8)	Default Settings
A1 – A8	87.50 / 89.10 / 98.10 / 107.90 / 90.10 / 90.10 / 90.10 / 90.10 MHz
B1 – B8	520 / 600 / 1000 / 1400 / 1500 / 1710 kHz, 90.10 / 90.10 MHz
C1 – C8	90.10 MHz
D1 – D8	90.10 MHz
E1 – E8	90.10 MHz
F1 – F8	90.10 MHz
G1 – G8	90.10 MHz

Specify a name for the preset broadcast station (Preset Name) (page 69)

Listening to preset stations

1 Press **SHIFT** to select the memory block (A to G).

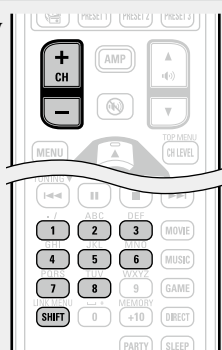
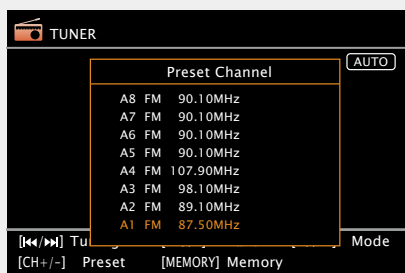

2 Press **CH +**, **CH -** or **1 - 8** to select the desired preset channel.



You can also operate via the main unit. In this case, perform the following operations.

Press **TUNER PRESET CH +** or **TUNER PRESET CH -** to select a preset radio station.

Direct frequency tuning

You can enter the receiving frequency directly to tune in.

1 Press **SEARCH**.

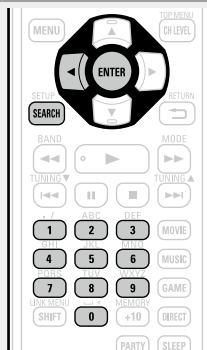
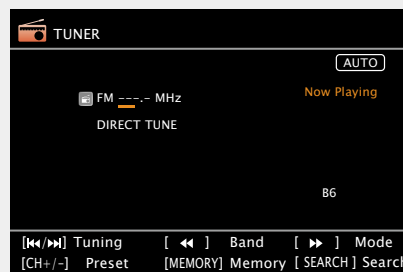

2 Input frequencies using the **0 - 9**.

• If **<** is pressed, the immediately preceding input is cancelled.

3 When setting is completed, press **ENTER**.

The preset frequency is tuned in.

Tuner (FM/AM) operation



Operation buttons	Function
CH +, -	Preset channel selection
MENU	Amp menu
△▽◀▶	Cursor operation
ENTER	Enter
SEARCH	Direct frequency tuning
RETURN	Return
BAND	FM/AM switching
MODE	Switch search modes
TUNING ▲▼	Tuning (up/down)
0 - 9	Preset channel selection (1 - 8) / Direct frequency tuning (0 - 9)
SHIFT	Preset channel block selection
MEMORY	Preset memory registration
TV I / ⏻	TV power on/standby (Default : SONY)
TV INPUT	Switch TV input (Default : SONY)

Selecting a listening mode (Surround mode)

This unit can play input audio signals in multi-channel surround mode or in stereo mode.

Select a listening mode suitable for the playback contents (cinema, music, etc.) or according to your liking.

Selecting a listening mode

1 Play the selected device
(page 21 – 25).

2 Press **MOVIE**, **MUSIC**, **GAME** or **DIRECT** to select a listening mode.

• Each time **MOVIE**, **MUSIC** or **GAME** is pressed, the listening mode is switched.

MOVIE Switches to the listening mode suitable for enjoying movies and TV programs.

MUSIC Switches to the listening mode suitable for enjoying music.

GAME Switches to the listening mode suitable for enjoying games.

DIRECT Switches the listening mode to Direct or Pure Direct mode. In Direct mode, the audio is played back exactly how it was recorded.

• Pressing **MOVIE**, **MUSIC** or **GAME** displays a list of the surround modes that can be selected on the TV screen. While the list is displayed, you can also use Δ / ∇ to select a surround mode.

[Example] When **MOVIE** is pressed

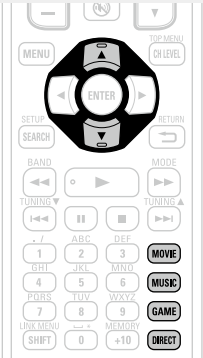
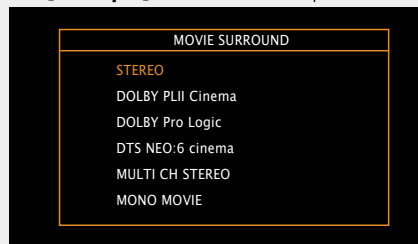

Listening mode

- The following listening modes can be selected using the **MOVIE**, **MUSIC**, **GAME**, and **DIRECT** buttons.
- Adjust the sound field effect with the menu "Surr.Parameter" (page 53) to enjoy your favorite sound mode.

Operation button	Input signal	Listening mode	
MOVIE	2-channel *1	STEREO	
		DOLBY PLIIx Cinema *2	
		DOLBY PLII Cinema *2	
		DOLBY Pro Logic *2	
		DTS NEO:6 Cinema *2	
		DOLBY PLIIz Height *2	
		MULTI CH STEREO	
		MONO MOVIE	
		VIRTUAL	
		Multi-channel *3	Dolby Digital
	DOLBY DIGITAL		
	Dolby TrueHD		DOLBY DIGITAL EX
			DOLBY DIGITAL + PLIIx Cinema
			DOLBY DIGITAL + PLIIz
	Dolby TrueHD		DOLBY TrueHD
			DOLBY TrueHD + EX
			DOLBY TrueHD + PLIIx Cinema
	Dolby Digital Plus		DOLBY TrueHD + PLIIz
			DOLBY DIGITAL Plus
		DOLBY DIGITAL Plus + EX	
DTS	Dolby Digital Plus	DOLBY DIGITAL Plus + PLIIx Cinema	
		DOLBY DIGITAL Plus + PLIIz	
		DTS SURROUND	
	DTS	DTS ES DSCRT 6.1	
		DTS ES MTRX 6.1	
		DTS 96/24	
		DTS 96 ES MTRX	
		DTS ES DSCRT	
		DTS + NEO:6	
		DTS + PLIIx Cinema	
DTS + PLIIz			
DTS-HD / DTS Express	DTS-HD HI RES		
	DTS-HD MSTR		
	DTS Express		
	DTS-HD + NEO:6		
	DTS-HD + PLIIx Cinema		
DTS-HD + PLIIz			

Operation button	Input signal	Listening mode
MOVIE	PCM multi-channel	MULTI CH IN
		MULTI CH IN 7.1
		MULTI IN + Dolby EX
		MULTI IN + PLIIx Cinema
		MULTI IN + PLIIz
	Multi-channel *3	MULTI CH STEREO
		MONO MOVIE
		VIRTUAL

*1 2-channel also includes analog input.

*2 This mode plays back 2-channel source in 5.1 or 7.1-channel playback. It cannot be selected when headphones are used, or when only front speakers are used.

*3 Some listening modes cannot be selected, depending on the audio format or number of channels of the input signal. For details, see "Types of input signals, and corresponding surround modes" (page 89).

Operation button	Input signal	Listening mode
MUSIC	2-channel *1	STEREO
		DOLBY PLIIx Music *2
		DOLBY PLII Music *2
		DTS NEO:6 Music *2
		DOLBY PLIIz Height *2
		MULTI CH STEREO
		ROCK ARENA
		JAZZ CLUB
	MATRIX	
	VIRTUAL	
	Multi-channel *3	STEREO
	Dolby Digital	DOLBY DIGITAL
		DOLBY DIGITAL EX
		DOLBY DIGITAL + PLIIx Music
		DOLBY DIGITAL + PLIIz
	Dolby TrueHD	DOLBY TrueHD
		DOLBY TrueHD + EX
		DOLBY TrueHD + PLIIx Music
		DOLBY TrueHD + PLIIz
	Dolby Digital Plus	DOLBY DIGITAL Plus
		DOLBY DIGITAL Plus + EX
		DOLBY DIGITAL Plus + PLIIx Music
		DOLBY DIGITAL Plus + PLIIz
	DTS	DTS SURROUND
		DTS ES DSCRT 6.1
		DTS ES MTRX 6.1
		DTS 96/24
		DTS 96 ES MTRX
		DTS ES DSCRT
		DTS + NEO:6
		DTS + PLIIx Music
	DTS + PLIIz	
	DTS-HD / DTS Express	DTS-HD HI RES
DTS-HD MSTR		
DTS Express		
DTS-HD + NEO:6		
PCM multi-channel	DTS-HD + PLIIx Music	
	DTS-HD + PLIIz	
	MULTI CH IN	
	MULTI CH IN 7.1	
Multi-channel *3	MULTI IN + Dolby EX	
	MULTI IN + PLIIx Music	
	MULTI IN + PLIIz	
	MULTI CH STEREO	
	ROCK ARENA	
	JAZZ CLUB	
MATRIX		
VIRTUAL		

Operation button	Input signal	Listening mode
GAME	2-channel *1	STEREO
		DOLBY PLIIx Game *2
		DOLBY PLII Game *2
		DOLBY PLIIz Height *2
		MULTI CH STEREO
		VIDEO GAME
		VIRTUAL
		Multi-channel *3
	Dolby Digital	DOLBY DIGITAL
		DOLBY DIGITAL EX
	Dolby TrueHD	DOLBY TrueHD
		DOLBY TrueHD + EX
	Dolby Digital Plus	DOLBY DIGITAL Plus
		DOLBY DIGITAL Plus + EX
	DTS	DOLBY DIGITAL Plus + PLIIz
		DOLBY TrueHD + PLIIz
		DOLBY DIGITAL Plus
		DOLBY DIGITAL Plus + EX
		DOLBY DIGITAL Plus + PLIIz
		DTS SURROUND
		DTS ES DSCRT 6.1
		DTS ES MTRX 6.1
	DTS 96/24	
	DTS-HD / DTS Express	DTS 96 ES MTRX
		DTS ES DSCRT
		DTS + NEO:6
		DTS + PLIIz
	PCM multi-channel	DTS-HD HI RES
		DTS-HD MSTR
		DTS Express
		DTS-HD + NEO:6
	Multi-channel *3	DTS-HD + PLIIz
		MULTI CH IN
MULTI CH IN 7.1		
MULTI IN + Dolby EX		
DIRECT	MULTI IN + PLIIx Music	
	MULTI IN + PLIIz	
	MULTI CH STEREO	
All	VIDEO GAME	
	VIRTUAL	
All	DIRECT	
	PURE DIRECT	

- *1 2-channel also includes analog input.
- *2 This mode plays back 2-channel source in 5.1 or 7.1-channel playback. It cannot be selected when headphones are used, or when only front speakers are used.
- *3 Some listening modes cannot be selected, depending on the audio format or number of channels of the input signal. For details, see "Types of input signals, and corresponding surround modes" (page 89).

Views on the TV screen or display

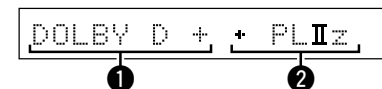

- 1 Shows a decoder to be used.
 - A DOLBY DIGITAL Plus decoder is displayed as "DOLBY D +".
- 2 Shows a decoder that creates sound output from the surround back speakers.
 - "+ PLIIz" indicates the front height sound from front height speakers.

□ Description of listening mode types

Dolby listening mode

Listening mode type	Description
DOLBY PLIIx*1	This mode can be selected when a Dolby Pro Logic IIx decoder is used to play back 2-channel source in 6.1/7.1-channel surround sound including the surround back channel. By adding the surround back channel, a stronger surround feeling is obtained compared to Dolby Pro Logic II. There are three playback modes: "Cinema" mode that is optimized for movie playback, "Music" mode that is optimized for music playback, and "Game" mode that is optimized for game play.
DOLBY PLII	This mode can be selected when a Dolby Pro Logic II decoder is used to play back 2-channel source in 5.1-channel surround sound with a natural, realistic feel.
DOLBY Pro Logic	This mode can be selected when a DOLBY Pro Logic decoder is used to play 2-channel source in 4.1-channel surround sound (Left/Center/Right/Surround Mono).
DOLBY PLIIz*2	This mode can be selected when a Dolby Pro Logic IIz decoder is used to play back 2-channel source in 7.1-channel surround sound with added front height channel. By adding a front height channel, the vertical expression is emphasized, improving the three-dimensionality of the sound.
DOLBY DIGITAL	This mode can be selected when playing sources recorded with Dolby Digital.
DOLBY DIGITAL EX*1	This mode improves the depth, dimension, and expressiveness of the sound stage by sound field playback including surround back channels.
DOLBY TrueHD	This mode can be selected when playing sources recorded in Dolby TrueHD.
DOLBY DIGITAL Plus	This mode can be selected when playing sources recorded with Dolby Digital Plus.

*1 This can be selected when "Speaker Config." – "S.Back" is not set to "None".

*2 This can be selected when "Speaker Config." – "F.Height" is not set to "None".

DTS listening mode

Listening mode type	Description
DTS NEO:6	This mode can be selected when a DTS NEO:6 decoder is used to play back 2-channel source in 6.1/7.1-channel surround sound including the surround back channel. There is a "Cinema" mode optimized for movie playback, and a "Music" mode optimized for music playback.
DTS SURROUND	This mode can be selected when playing sources recorded in DTS.
DTS ES DSCRT6.1*	This mode can be selected when playing sources recorded in DTS-ES. Provides optimum playback of DTS-ES Discrete signals using surround back.
DTS ES MTRX6.1*	This mode can be selected when playing sources recorded in DTS-ES. Surround back channel data encoded in DTS-ES Matrix recording software is played from the surround back channel.
DTS 96/24	This mode can be selected when playing sources recorded in DTS 96/24.
DTS-HD	This mode can be selected when playing sources recorded in DTS-HD.
DTS Express	This mode can be selected when playing sources recorded in DTS Express.

* This can be selected when "Speaker Config." – "S.Back" is not set to "None".

PCM multi-channel listening mode

Listening mode type	Description
MULTI CH IN	This mode can be selected when playing multi-channel PCM sources .

DENON original listening mode

Listening mode type	Description
MULTI CH STEREO	This mode is for enjoying stereo sound from all speakers. The same sound as that from the front speakers (L/R) is played back at the same level from the surround speakers (L/R) and surround back speakers (L/R).
ROCK ARENA	This mode is for enjoying the atmosphere of a live concert in an arena.
JAZZ CLUB	This mode is for enjoying the atmosphere of a live concert in a jazz club.
MONO MOVIE	This mode is for playing monaural movie sources with surround sound. When playing sources recorded in monaural in the "MONO MOVIE" mode, the sound will be off balance with a single channel (left or right), so input to both channels.
VIDEO GAME	This mode is suited for achieving surround sound with video games.
MATRIX	This mode lets you add a spacious feel to stereo music sources.
VIRTUAL	This mode is for enjoying surround effects using only the front speakers or headphones.

STEREO listening mode

Listening mode type	Description
STEREO	This is the mode for playing in stereo. The tone can be adjusted. <ul style="list-style-type: none"> • Sound is output from the front left and right speakers and subwoofer. • If multichannel signals are input, they are mixed down to 2-channel audio and are played.

Direct listening mode

Listening mode type	Description
DIRECT	Sound recorded in source is played as is. <ul style="list-style-type: none"> • Surround back signals or front height signals are not created.
PURE DIRECT	This mode is for playback in higher sound quality than in "Direct playback" mode. Turn the display of the amplifier off to stop the analogue video circuit. This suppresses the source of noise that affects sound quality. <ul style="list-style-type: none"> • Surround back signals or front height signals are not created.



In Direct listening mode, the following items cannot be adjusted.





- Tone ([page 55](#))
- MultEQ® XT ([page 55](#))
- Dynamic EQ® ([page 56](#))
- RESTORER ([page 57](#))

NOTE

- Video signals are only output when HDMI signals are played in the PURE DIRECT mode.
- When in the PURE DIRECT mode, the menu screen is not displayed.

Advanced version

Here, we explain functions and operations that let you make better use of this unit.

- **Speaker installation/connection (Advanced connection)**  [page 32](#)
- **Playback (Advanced operation)**  [page 41](#)
- **Playback in ZONE2 (Separate room)**  [page 45](#)
- **How to make detailed settings**  [page 47](#)
- **Operating the connected devices by remote control unit**  [page 74](#)

Speaker installation/connection (Advanced connection)

Here we describe the installation, connection and setup methods for speakers other than 5.1-channel speakers. For the installation, connection and setup methods for 5.1-channel speakers, see [page 4](#) "Setup Wizard".

Use Audyssey® Auto Setup function of this unit to automatically detect the number of connected speakers and perform optimal settings for the speakers to be used.

Procedure for speaker settings

Install

Connect ([page 34](#))

Set up speakers ([page 39](#))

Install

This unit is compatible with Dolby Pro Logic IIz ([page 92](#)), which offers an even wider and deeper surround sensation. When using Dolby Pro Logic IIz, install front height speakers.



Install the surround back speakers in a position 2 to 3 ft (60 to 90 cm) higher than ear level.

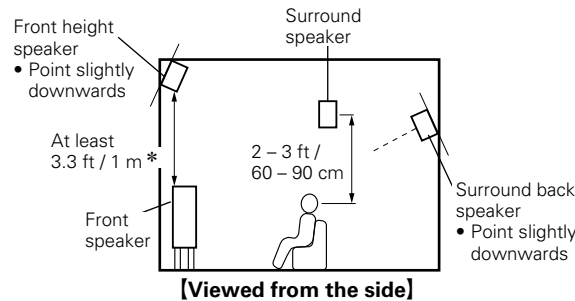

* Recommended for Dolby Pro Logic IIz

NOTE

It is not possible to use the surround back speakers and front height speakers simultaneously.

When 7.1ch (Surround back speaker) installed

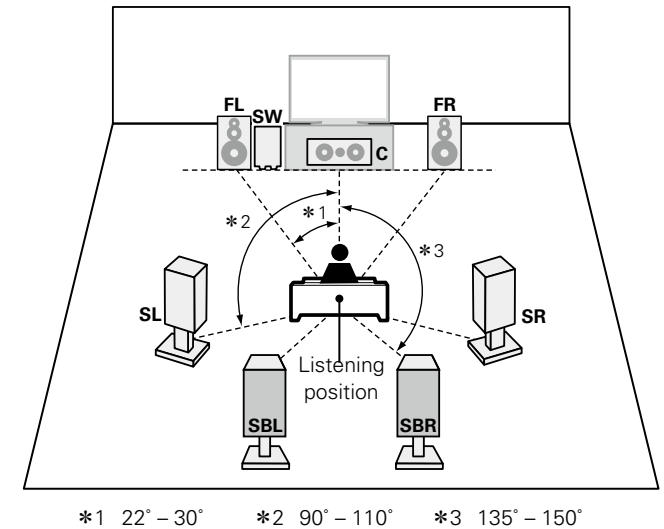

- [Speaker abbreviations]**
- | | |
|-----------------------------|--------------------------------------|
| FL Front speaker (L) | SL Surround speaker (L) |
| FR Front speaker (R) | SR Surround speaker (R) |
| C Center speaker | SBL Surround back speaker (L) |
| SW Subwoofer | SBR Surround back speaker (R) |

When 7.1ch (Front height speaker) installed

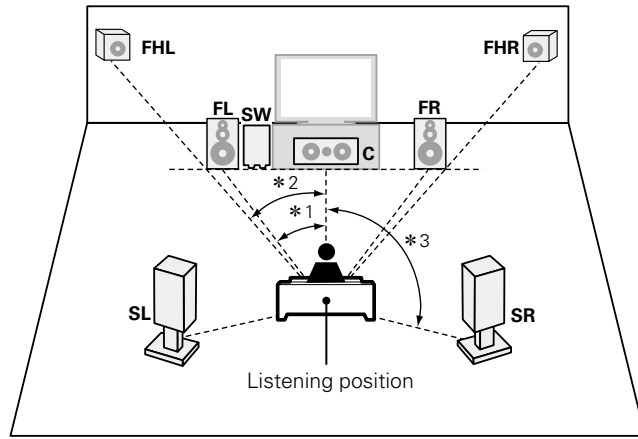

*1 22° - 30° *2 22° - 45° *3 90° - 110°

[Speaker abbreviations]

- | | |
|--------------------------------|-------------------------------------|
| FL Front speaker (L) | SB Surround back speaker |
| FR Front speaker (R) | FHL Front height speaker (L) |
| C Center speaker | FHR Front height speaker (R) |
| SW Subwoofer | |
| SL Surround speaker (L) | |
| SR Surround speaker (R) | |

When 6.1ch (Surround back speaker) installed

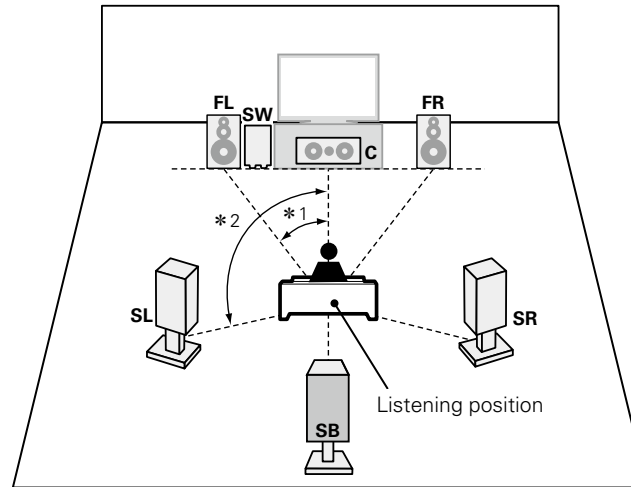

*1 22° - 30° *2 90° - 110°

When Front A/B speakers installed

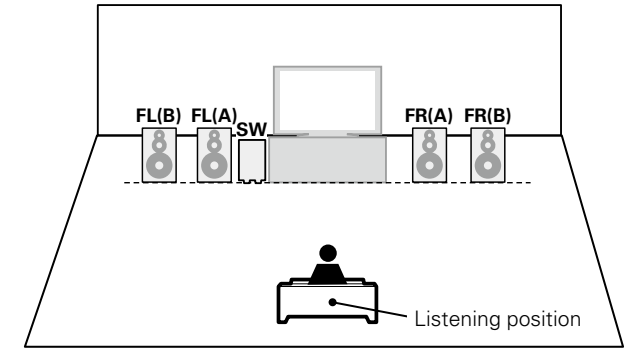

Connect

- For the method of connecting 5.1-channel speakers, see [page 6 “Connecting the speakers”](#).
- For the method of connecting the TV, see [page 3 “Connect this unit to the television using an HDMI cable \(sold separately\)”](#).

7.1-channel (Surround back speaker) connection

The illustration on the right shows a connection example for performing 7.1-channel playback using the surround back speakers.

If you connect the surround back and front height speakers before you start playback, the audio is played back by automatically switching the speakers in accordance with the surround mode or input signals.

To perform 7.1-channel playback using the surround back speakers, set “Amp Assign” to “NORMAL” in steps 3 and 4 for “Set up “Amp Assign”” ([page 39](#)).

NOTE

- For speaker cable connections, see [page 6 “Connecting the speakers”](#).
- Connect so that the speaker cable core wires do not protrude from the speaker terminal. The protection circuit may be activated if the core wires touch the rear panel or if the + and – sides touch each other ([page 93 “Protection Circuit”](#)).
- Never touch the speaker terminals while the power supply is connected. Doing so could result in electric shock. (When the Setup wizard is running, follow the instructions in the Setup wizard screen for making connections.)
- Use speakers with the speaker impedances shown below.

Speaker terminals	Speaker impedance
FRONT	6 – 16 Ω
CENTER	
SURROUND	
SURR. BACK / AMP ASSIGN	

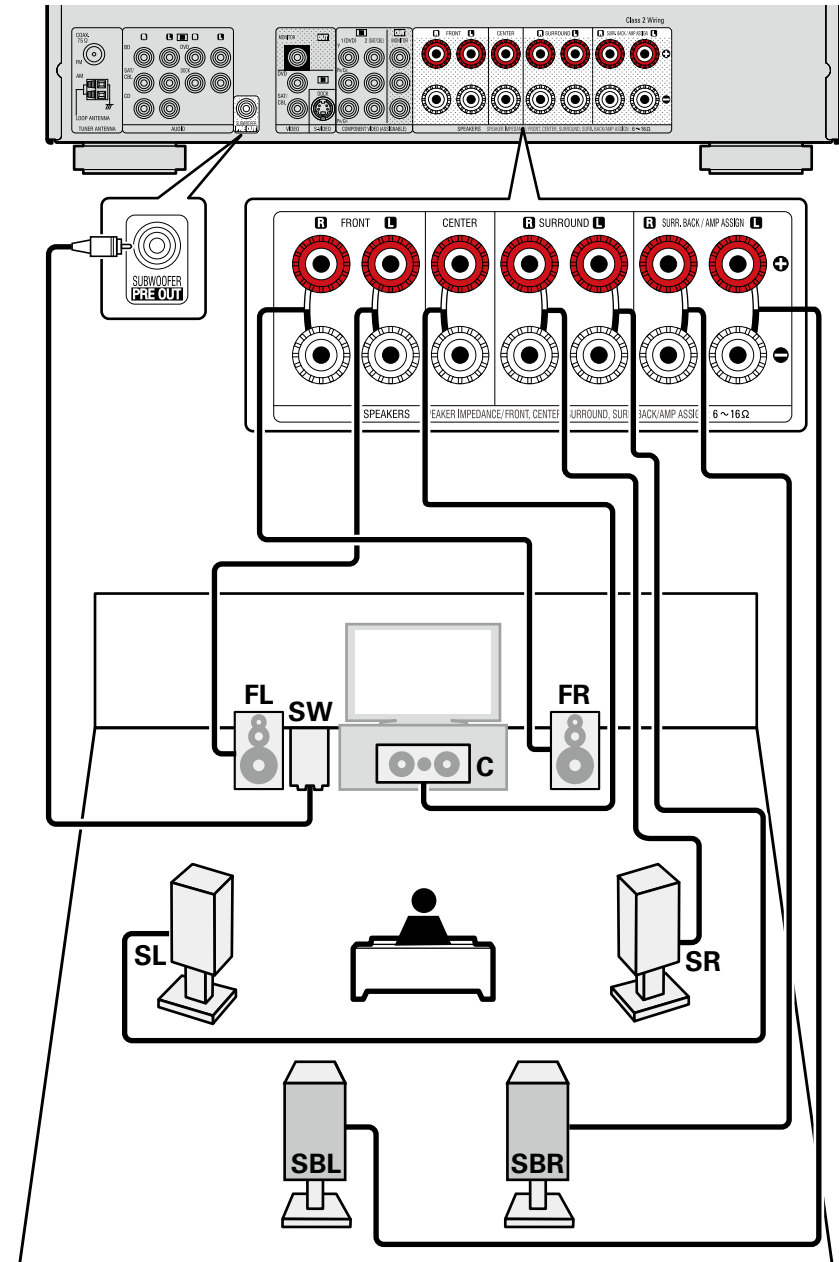

7.1-channel (Front height speaker) connection

The illustration on the right shows a connection example for performing 7.1-channel playback using the front height speakers.

If you connect the surround back and front height speakers before you start playback, the audio is played back by automatically switching the speakers in accordance with the surround mode or input signals.

To perform 7.1-channel playback using the front height speaker, set "Amp Assign" to "F.HEIGHT" in steps 3 and 4 for "Set up "Amp Assign"" ([page 39](#)).

NOTE

- For speaker cable connections, see [page 6 "Connecting the speakers"](#).
- For speaker impedance, see [page 34](#).

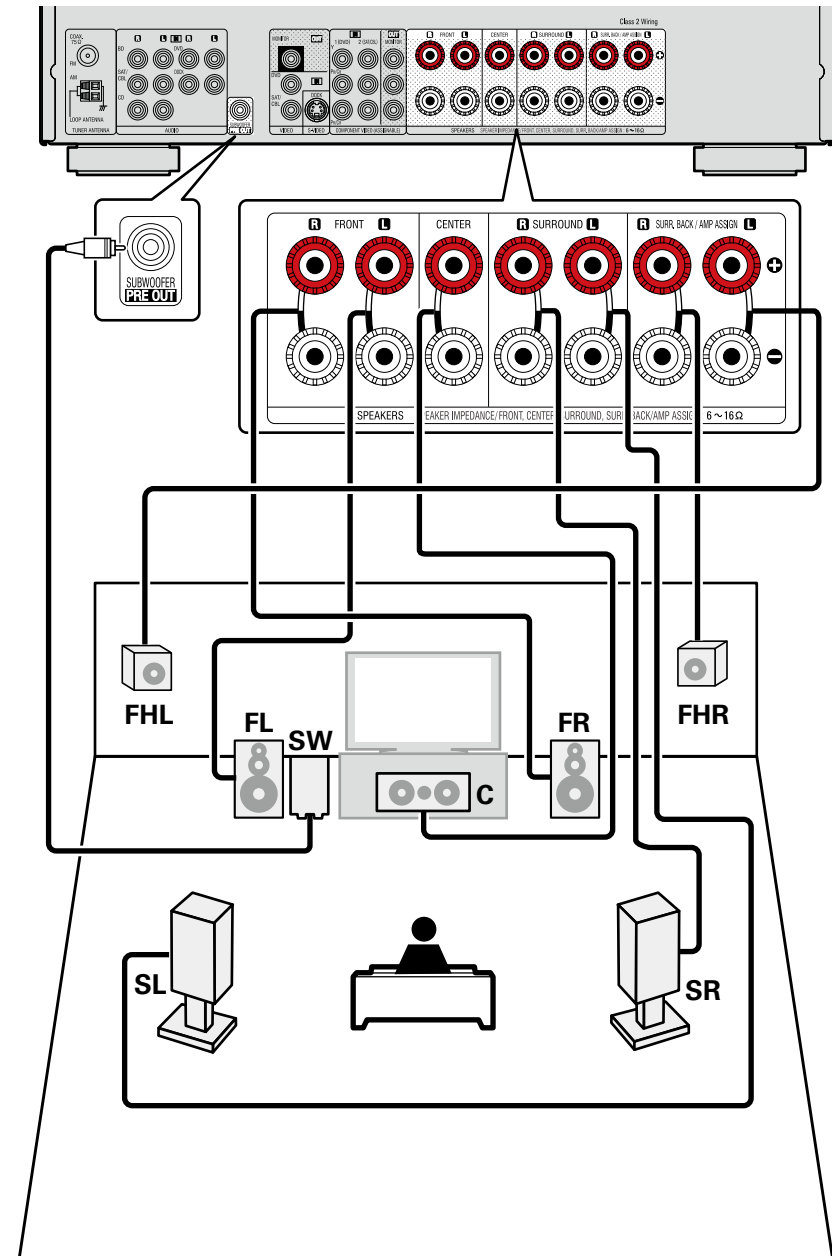

6.1-channel (Surround back speaker) connection

If using only one surround back speaker (with a 6.1-channel connection), connect to the “L” side of the SURR. BACK/AMP ASSIGN terminal.

For speaker settings in this case, see “When 6.1ch (Surround back speaker) installed” (page 33).

To perform 6.1-channel playback using the surround back speaker, set “Amp Assign” to “NORMAL” in steps 3 and 4 for “Set up “Amp Assign”” (page 39).

Also use the “Speaker Config.” setting (page 60) to set “S.Back” to “1spkr”.

NOTE

- For speaker cable connections, see page 6 “Connecting the speakers”.
- For speaker impedance, see page 34.

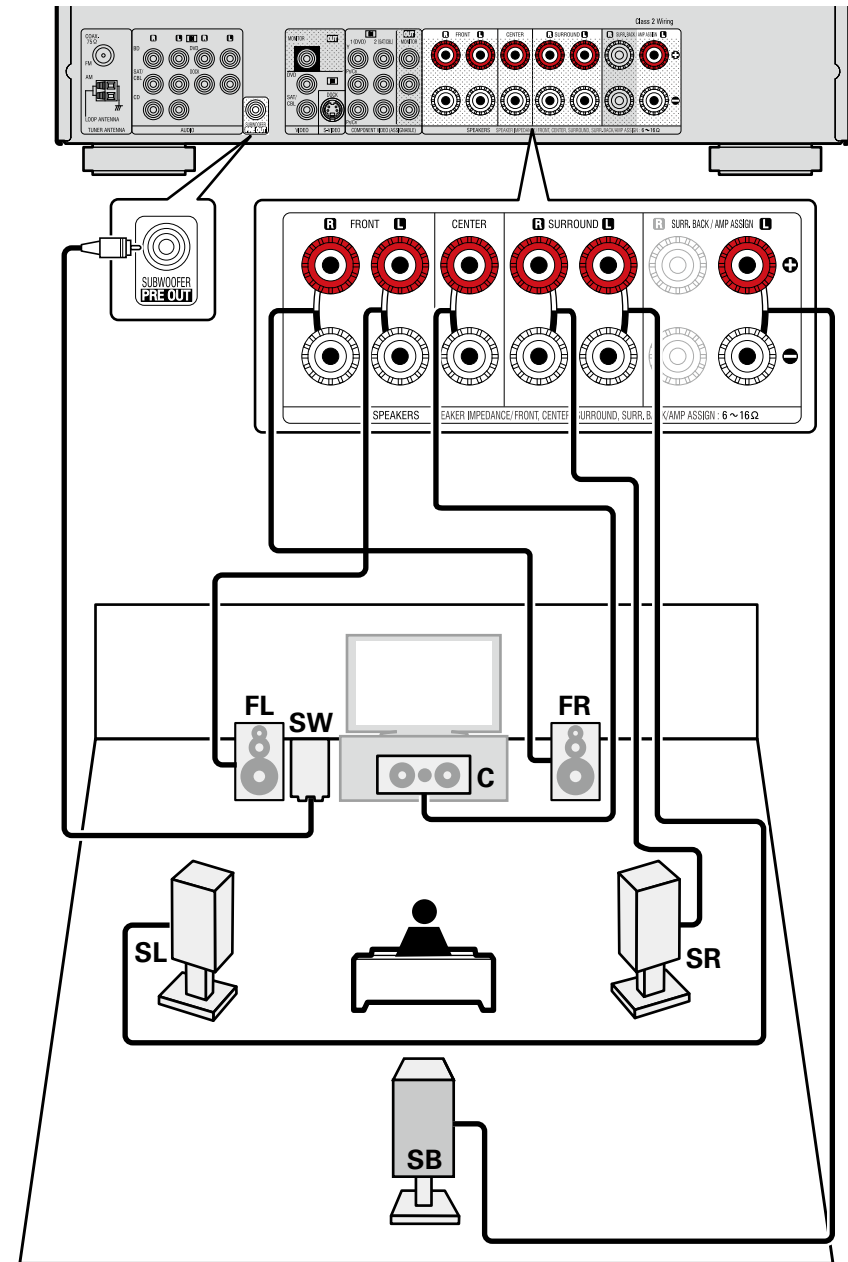

Front A/B connection

You can connect a second set of speakers to this unit and use them for playback. In this case, set "Amp Assign" to "Front B" in steps 3 and 4 for "Set up "Amp Assign"" ([page 39](#)).

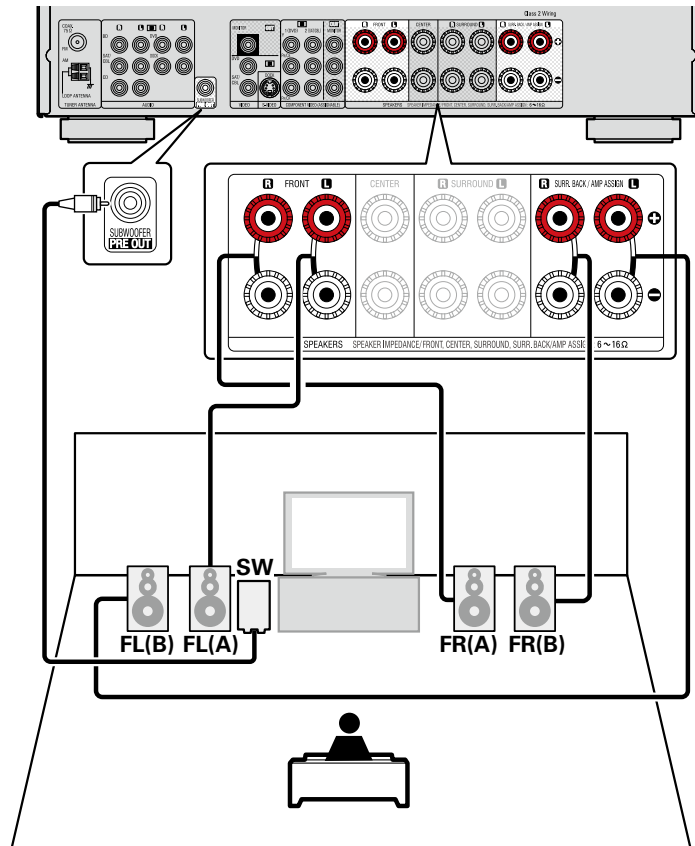

For surround playback of a multichannel source, if you connect the center speaker, surround speakers and subwoofers, 5.1-channel playback is available.

Front speakers can be used separately, depending on the speaker's specifications or playback source such as front speakers (A) for multichannel playback and front speakers (B) for 2-channel playback ([page 62](#) "Front Sp Setup").

NOTE

- For speaker cable connections, see [page 6 "Connecting the speakers"](#).
- For speaker impedance, see [page 34](#).

2.1-channel connection

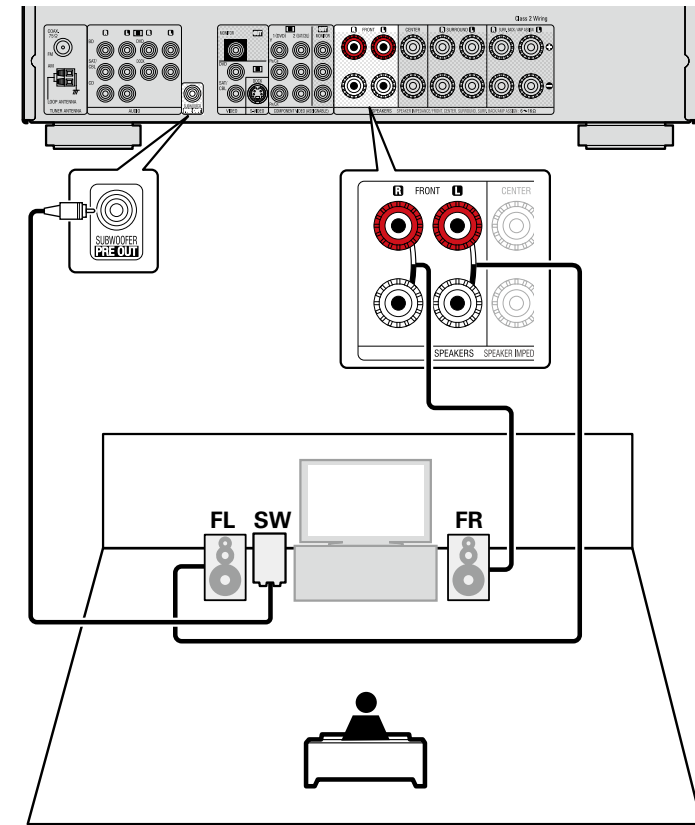

NOTE

- For speaker cable connections, see [page 6 "Connecting the speakers"](#).
- For speaker impedance, see [page 34](#).

Bi-Amp connection

You can use the front speakers via the bi-amp connection.

A bi-amp connection is to connect separate amplifiers to the tweeter terminals and woofer terminals of speakers compatible with the bi-amp function. This prevents the back electromotive force (returned force without output) of the woofer sent to the tweeter, which affects the sound quality of the tweeter, and you can enjoy playback with higher-quality sound.

In this case, set "Amp Assign" to "Bi-AMP" in steps 3 and 4 for "Set up "Amp Assign"" (🔗 [page 39](#)).



For surround playback of a multichannel source, if you connect the center speaker, surround speakers and subwoofers, 5.1-channel playback is available.

NOTE

- For speaker cable connections, see 📖 [page 6 "Connecting the speakers"](#).
- For speaker impedance, see [page 34](#).
- Use speakers compatible with bi-amp connections.
- When making bi-amp connections, be sure to remove the short-circuiting plate or wire between the speaker's woofer and tweeter terminals.

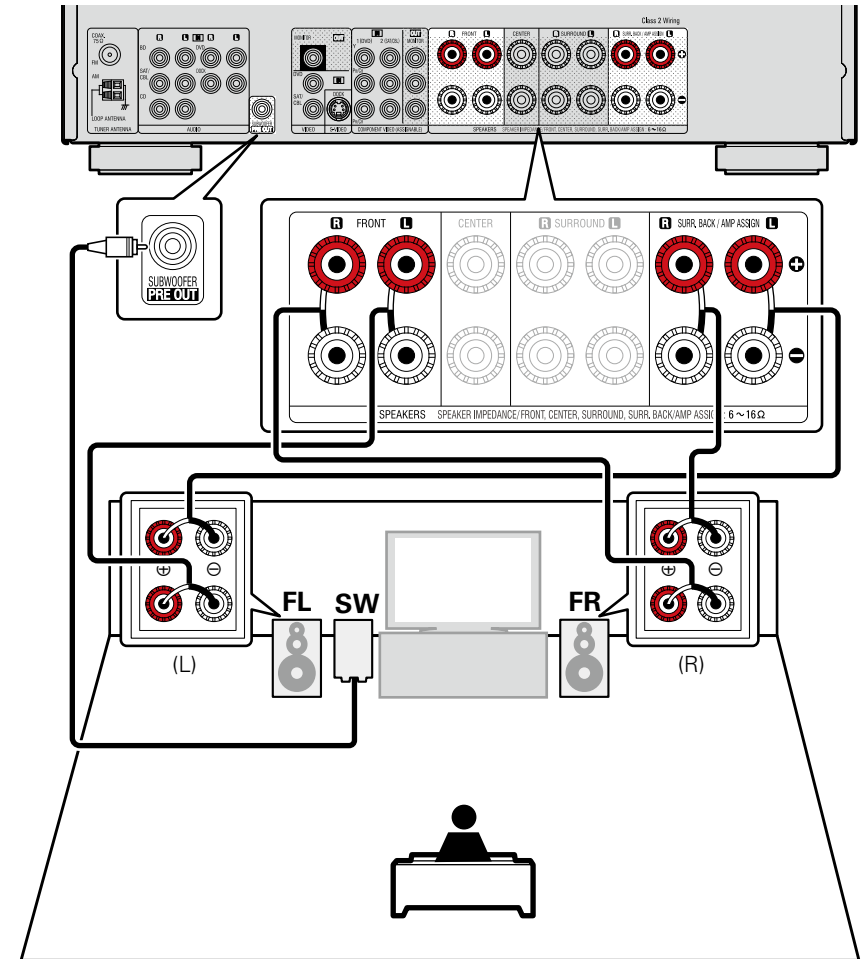

Set up speakers

 around items indicate the settings.

Here we describe how to set up speakers other than 5.1-channel speakers.
For the method of setting up 5.1-channel speakers, see [page 4](#) “Setup wizard”.

First install and connect the speakers to this unit.

Before Auto Setup measurement, the settings shown below can be made.

- Changing the amplifier assignment (Amp Assign)
The signal output from the SURR.BACK/AMP ASSIGN speaker terminal of this unit can be switched to match your speaker environment ([page 39](#) “Set up “Amp Assign””).
- Setting the channels to be used (Channel Select)
If channels that are not to be used are set in advance, measurement for the set channels is skipped, and measuring time can be reduced. You can also change the number of surround back speakers ([page 40](#) “Set up “Channel Select””).

1 Set up the remote control unit

Set up the zone mode
Press **ZONE SELECT** to switch the zone mode to **M** (MAIN ZONE).
The **M** indicator lights.

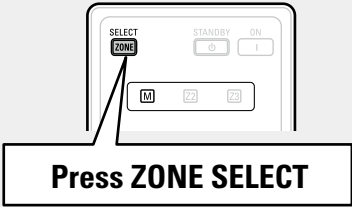

Set up the operation mode
Press **AMP** to set the remote control unit to AMP-operation mode.

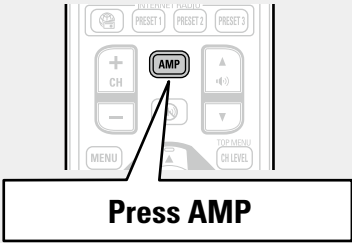

2 Connect the setup microphone.

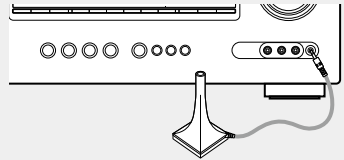

When the setup microphone is connected, the following screen is displayed.

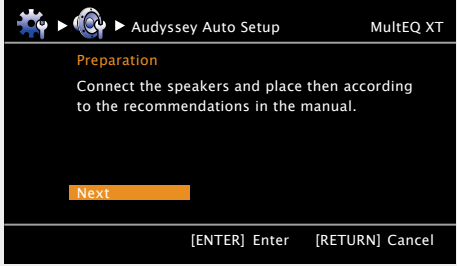

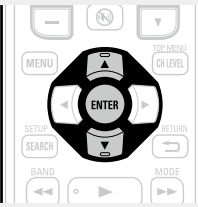

3 Select “Next”, and then press ENTER.

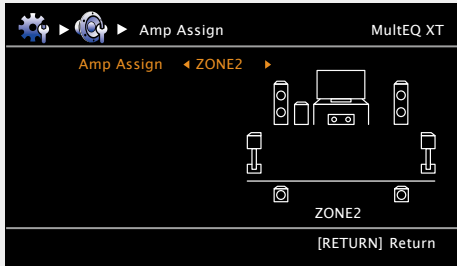

4 Set up “Amp Assign”

Use Δ / ∇ to select “Amp Assign”, and then press ENTER.

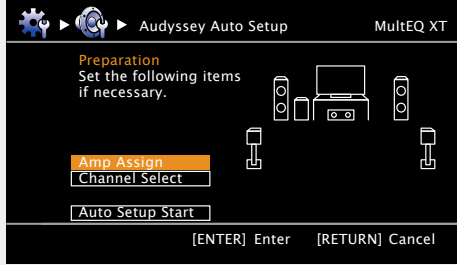

5 Use ◀ ▶ to select the configuration of the connected speakers.

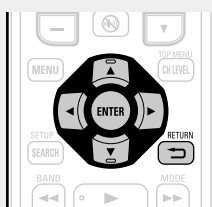

NORMAL Select the "NORMAL" setting to perform 7.1-channel playback using the surround back speakers.

ZONE2 Select the "ZONE2" setting to assign the unit's built-in power amplifier for ZONE2 and output the audio in stereo.

Bi-AMP Select the "Bi-AMP" setting to connect the front speakers via the bi-amp connection.

Front B Select the "Front B" setting to use the second set of front speakers for playback.

F.HEIGHT Select the "F.HEIGHT" setting to use the front height speaker for playback.

6 Press **RETURN** ↵ to exit the "Amp Assign" setting.

7 Set up "Channel Select"

Use ▲▼ to select "Channel Select", and then press **ENTER**.

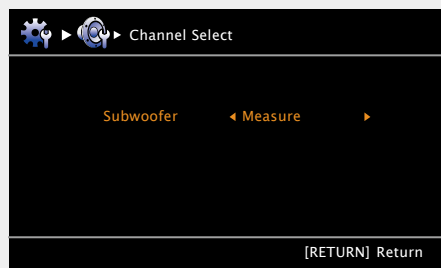
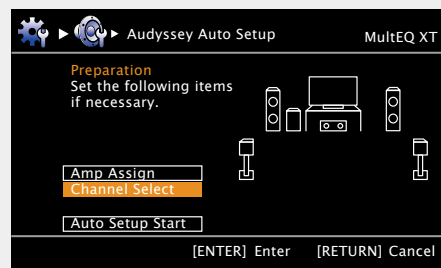

8 Use ▲▼ to select a channel.

Front Select for setting the front speakers to be used. In this case, go to step 9.

- "Front" can be set when "Amp Assign" is set to "Front B".

Subwoofer Select for no subwoofer to be used. In this case, go to step 10.

Surround Back Select the number of surround back speakers to be used. In this case, go to step 11.

- "Surround Back" can be set when "Amp Assign" is set to "NORMAL".

9 Press ◀ ▶ to select a front speaker.

A Select this to use front speaker A.

B Select this to use front speaker B.

A+B Select this to use front speakers A and B simultaneously.

10 Use ◀ ▶ to set whether or not a subwoofer channel is measured.

Measure Set for measuring a subwoofer.

Skip Set for no measuring of a subwoofer.

11 Use ◀ ▶ to set whether or not a surround back channel is measured.

Measure (2 sp) Set for measuring two surround back speakers.

Measure (1 sp) Set for measuring a surround back speaker.

Skip Set for no measuring of a surround back speaker.

12 Press **RETURN** ↵. Proceed to [page 15](#) **STEP1 Preparation** step 6.

NOTE

After performing Audyssey® Auto Setup, do not change the speaker connections or subwoofer volume. In event of a change, perform Audyssey® Auto Setup again.

Playback (Advanced operation)

Settings (🔗 page 13)

Playback (Basic operation) (🔗 page 20)

Selecting a listening mode (Surround mode)
(🔗 page 27)

HDMI control function (🔗 page 41)

Sleep timer function (🔗 page 42)

Adjusting the volume of the speakers
(🔗 page 43)

Quick select function (🔗 page 44)

Various memory functions (🔗 page 44)

Convenient functions

HDMI control function

If you connect the unit and an HDMI control function compatible TV or player with an HDMI cable and then enable the HDMI control function setting on each device, the devices will be able to control each other.

Operations possible by HDMI control

- This unit power off can be linked to the TV power off step.
- You can switch audio output devices with a TV operation.
When you set "Output audio from amp" in the TV audio output setup operation, you can switch the amp power on.
- You can adjust this unit volume in the TV volume adjustment operation.
- You can switch this unit input sources through linkage to TV input switching.
- When playing the player, this unit input source switches to the source for that player.
- If you switch the input source of the unit to "TV", you can play TV audio with this unit (🔗 page 6 "About ARC (Audio Return Channel) function").
- When "HDMI Control" (🔗 page 63) in the menu is set to "ON", signals input to the HDMI input connector are output to the television or other device connected to the HDMI output connector, even if the power of this unit is in standby (pass-through function).



- To play the audio of a TV that does not support the ARC function with the unit, connect the TV with an optical digital connection.
- To use the pass-through function, connect an HDMI connection device that is compatible with HDMI control.

Setting procedure

- 1 Set the HDMI output connector corresponding with the HDMI control function.**
Set "HDMI Control" (🔗 page 63) to "ON".
- 2 Turn the power on for all the devices connected by HDMI cable.**
- 3 Set the HDMI control function for all devices connected by HDMI cable.**
 - Please consult the operating instructions for the connected devices to check the settings.
 - Carry out steps 2 and 3 should any of the devices be unplugged.
- 4 Switch the television input to the HDMI input connected to this unit.**
- 5 Switch this unit input to the HDMI input source and check if the picture from the player is ok.**
- 6 When you turn the TV's power to standby, check that the power of this unit also goes to standby.**



If the HDMI control function does not operate properly, check the following points.

- Is the TV or player compatible with the HDMI control function?
- Is "HDMI Control" (🔗 page 63) set to "ON"?
- Is "P.Off Control" (🔗 page 63) set to "All" or "Video"?
- Are the HDMI control function settings of all devices correct?

NOTE

- When “HDMI Control” is set to “ON”, it consumes more standby power.
- The HDMI control function controls operations of a TV that is compatible with the HDMI control function. Make sure that the TV and HDMI are connected when you perform HDMI control.
- Some functions may not operate depending on the connected TV or player. Check the owner’s manual of each device for details beforehand.
- When “P.Off Control” on the menu is set to “OFF” ([page 63](#)), this unit is not set to standby even if the connected device is in the standby mode.
- When connection changes are implemented, such as adding connections to HDMI devices, linked operations may be initialized. In this case, you will need to reconfigure the settings.
- When “HDMI Control” is set to “ON”, it is not possible to assign an HDMI connector to “TV” at “Input Assign” ([page 70](#)).
- Should any of the operations below be performed, the interlocking function may be reset, in which case, repeat steps 2 and 3.
 - “Input Assign” – “HDMI” ([page 70](#)) setting has changed.
 - There is a change to the connection between the devices and the HDMI, or an increase in devices.

Sleep timer function

The power automatically goes into standby once the set time has elapsed.

This is convenient for playing sources while going to sleep.

Press SLEEP and display the time you want to set.

The “SLEEP” indicator on the display lights.

- The time switches as shown below each time **SLEEP** is pressed.

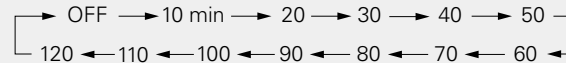

- If **SLEEP** on the main unit is pressed, the same function as with the remote control unit can be obtained.

**To confirm the countdown time before putting the unit to sleep**

Press **SLEEP**.

“Sleep : *min” appears on the display.

* Countdown time

To cancel the sleep timer

Press **SLEEP** to set “OFF”.

The “SLEEP” indicator on the display turns off.



- The sleep timer setting is canceled if this unit’s power is set to standby.
- The sleep timer function can be set separately for the different zones ([page 46](#) “Sleep timer function”).

Adjusting the volume of the speakers

You can adjust the channel level either according to the playback sources or to suit your taste, as described below.

Adjusting the volume of the different speakers

1 Press **ZONE SELECT** to switch the zone mode to **[M]** (MAIN ZONE). The **[M]** indicator lights.

2 Press **AMP** to set the remote control unit to AMP-operation mode.

3 Press **CH LEVEL**.

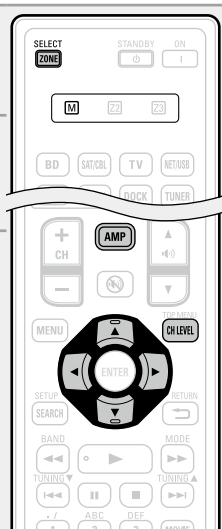
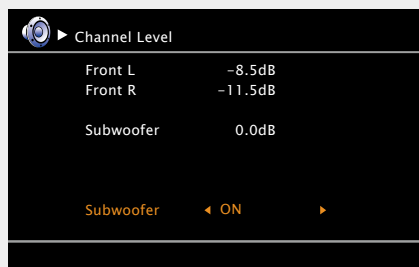

4 Use **△▽** to select the speaker.

The speaker that can be set switches each time one of the buttons is pressed.

5 Use **◀▶** to adjust the volume.

- You can directly turn “OFF” the subwoofer outputs during 2-channel playback in DIRECT or STEREO mode. Select “Subwoofer” and use **◀▶** to select “ON” or “OFF”.

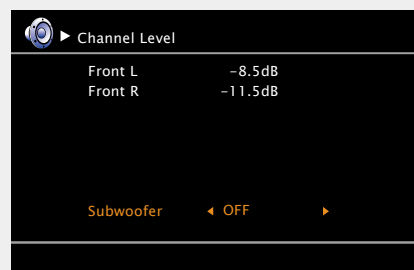

When a headphone jack is inserted, the headphone channel level can be adjusted.

Adjusting the volume of groups of speakers (Fader function)

This function lets you adjust (fade) the sound all at once from the front (front speaker / front height speaker / center speaker) or rear (surround speaker / surround back speaker).

1 Press **ZONE SELECT** to switch the zone mode to **[M]** (MAIN ZONE). The **[M]** indicator lights.

2 Press **AMP** to set the remote control unit to AMP-operation mode.

3 Press **CH LEVEL**.

4 Press **▽** to select “Fader”, then select the item to be adjusting using **◀▶**.

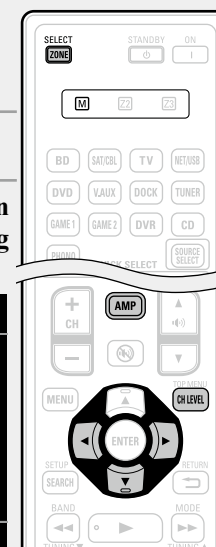
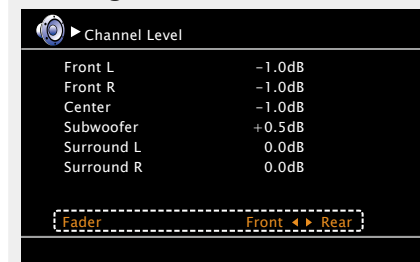

5 Use **◀▶** to adjust the volume of the speakers. (◀: front, ▶: rear)



- The fader function does not affect the subwoofer.
- The fader can be adjusted until the volume of the speaker is adjusted to the lowest value of -12 dB.

Quick select function

All of the settings in step 1 can be memorized together. By memorizing frequently used settings, you can quickly access and enjoy a playback environment that is consistently the same.

□ Saving the settings

1 Set the items below to the settings you want to save.

- ① Input source* ([page 20](#))
- ② Volume ([page 21](#))
- ③ Surround mode ([page 27](#))
- ④ Video Select ([page 71](#))
- ⑤ Audyssey Setting (Audyssey MultEQ® XT, Audyssey Dynamic EQ®, Audyssey Dynamic Volume®) ([page 55](#))



2 Press and hold the desired QUICK SELECT until “Memory” appears on the display.

The current settings will be memorized.

[Quick select defaults]

	Input source	Volume
QUICK SELECT 1	BD	-40 dB
QUICK SELECT 2	SAT/CBL	-40 dB
QUICK SELECT 3	GAME1	-40 dB
QUICK SELECT 4	DOCK	-40 dB

□ Recalling the settings

Press **QUICK SELECT** at which the settings you want to call out are saved.

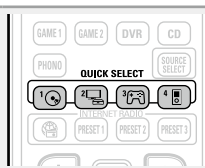

Naming quick select settings

See “Quick Sel.Name” ([page 66](#)).



- The Quick Select function can be set separately for the different zones ([page 46](#) “Quick select function”).
- If **QUICK SELECT** on the main unit is pressed, the same function as with the remote control unit can be obtained.

NOTE

Input sources stored with the quick select function cannot be selected if they have been deleted at “Source Delete” ([page 65](#)). In this case, store them again.

Various memory functions

□ Personal memory plus function

This function sets the settings (input mode, surround mode, HDMI output mode, MultEQ® XT, Dynamic EQ®, audio delay etc.) last selected for the individual input sources.



The surround parameters, tone settings and the volumes of the different speakers are stored for the individual surround modes.

□ Last function memory

This function stores the settings which were made before going into the standby mode.

When the power is turned back on, the settings are restored.

Playback in ZONE2 (Separate room)

- You can operate this unit so as to enjoy audio in a room (ZONE2) other than the MAIN ZONE (room where the unit is located).
- You can simultaneously play back the same source in both the MAIN ZONE, ZONE2. You can also play back separate sources in the MAIN ZONE and ZONE2.

Audio output

Zone playback by speaker output

The ZONE2 audio signals are output from this unit's SURR.BACK/AMP ASSIGN speaker terminals using the amplifier assignment function.

Connecting and setting the speakers

"Amp Assign" setting (page 60) and audio signals output	Connecting the speakers
<p>ZONE2 Output signal : Stereo (L / R)</p>	



We recommend using high quality pin-plug cables for audio connections in order to prevent noise.

NOTE

It is not possible to play the digital audio signals input from the HDMI, COAXIAL or OPTICAL connectors in ZONE2.

Playback

1 Press **ZONE SELECT** to switch the zone mode to **Z2** (ZONE2).

2 Press **AMP** to set the remote control unit to AMP-operation mode.

3 Press **ZONE/DEVICE 1** to turn on the ZONE2 power.

The **Z2** indicator on the display lights.

- Also press input source select button when in standby mode, the power turns on.
- When **ZONE/DEVICE 1** is pressed, ZONE2 turns off.
- Power in ZONE2 can be turned on or off by pressing **ZONE2 ON/OFF** on the main unit.

4 Press the input source select button.

The audio signal of the selected source is output to ZONE2.

- To perform an operation with the main unit, press **ZONE2 SELECT** many times.



When power for both MAIN ZONE and ZONE2 is set to ON, power of the MAIN ZONE only can be turned off. Select **M** (MAIN ZONE) in step 1 then press **ZONE/DEVICE 1**.

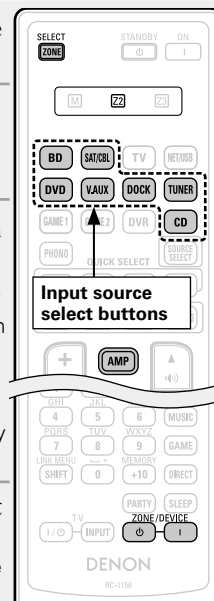

Adjusting the volume

Use **CH** ▲▼ to adjust the volume.



[Adjustable range] --- -80dB - -40dB - 18dB

(When the "Volume Display" ([page 65](#)) setting is "Relative")

[Adjustable range] 0 - 41 - 99

(When the "Volume Display" ([page 65](#)) setting is "Absolute")

- At time of purchase, "Volume Limit" ([page 65](#)) is set to "-10dB (71)".



Turn **MASTER VOLUME** after pressing **ZONE2 SELECT** on the main unit to adjust the sound volume.

Turning off the sound temporarily

Press **MUTE**.

The sound is reduced to the level set at "Mute Level" ([page 65](#)) in the menu.

- To cancel, either adjust the volume or press **MUTE** again.
- The setting is canceled when the zone's power is turned off.

Quick select function

It is also possible to save four settings for ZONE2.

□ Saving the settings

1 Set the items below to the settings you want to save.

- ① Input source (☞ [page 45](#))
- ② Volume (☞ [page 45](#))

2 Press ZONE SELECT to switch the zone mode to [Z2] (ZONE2).

3 In the zone mode for which you want to operate, press and hold the desired QUICK SELECT until “Memory” appears on the display.

The current settings will be memorized.



□ Recalling the settings

1 Press ZONE SELECT to switch the zone mode to [Z2] (ZONE2).

2 Press QUICK SELECT at which the settings you want to call out are saved.

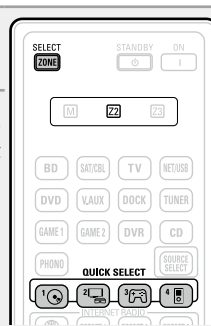

Naming quick select settings

See “Quick Sel.Name” (☞ [page 66](#)).

[Quick select defaults]

	Input source	Volume
ZONE2 QUICK SELECT 1	BD	-40dB
ZONE2 QUICK SELECT 2	SAT/CBL	-40dB
ZONE2 QUICK SELECT 3	-	-
ZONE2 QUICK SELECT 4	DOCK	-40dB

Sleep timer function

This is useful when you want to sleep while listening in ZONE2.

1 Press ZONE SELECT to switch the zone mode to [Z2] (ZONE2).

2 Press SLEEP and display the time you want to set.

- The time switches as shown below each time SLEEP is pressed.

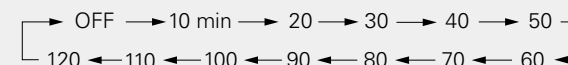

- If SLEEP on the main unit is pressed, the same function as with the remote control unit can be obtained.

To confirm the countdown time before putting the unit to sleep

Press SLEEP.

“Z2 Sleep : *min” appears on the display.

* Countdown time

To cancel the sleep timer

Press SLEEP to set “OFF”.



The sleep timer is also canceled when this unit is set to the standby mode or the ZONE2 power is turned off.

How to make detailed settings

Menu map

For menu operation, connect a TV to this unit and display the menu on the TV screen. For menu operations, see the following page.

Setting items	Detailed items	Description	Page
Audio Adjust	Surr.Parameter	Adjusts surround sound parameters.	53
	Tone	Adjusts the tonal quality of the sound.	55
	Audyssey Settings	Makes Audyssey MultEQ® XT, Audyssey Dynamic EQ® and Audyssey Dynamic Volume® settings.	55
	Manual EQ	Uses the graphic equalizer to adjust the tone of each speaker.	57
	RESTORER	Expands the low and high frequency components of compressed audio to enable richer audio playback.	57
Information	Audio Delay	Compensates for incorrect timing between video and audio.	57
	Status	Shows information about current settings.	58
	Audio Signal	Shows information about audio input signals.	58
	HDMI Information	Displays the HDMI input/output signals and HDMI monitor information.	58
	Auto Surround	Displays the settings stored for the auto surround mode.	58
	Quick Select	Displays the settings stored for the Quick Select function.	58
Setup Wizard	Preset Channel	Shows information about tuner preset channels.	58
		Perform the installation, connection, and setup procedures to prepare the unit for operation following guidance.	4
System Setup	Speaker Setup	Sets the speaker size and distance, the channel level, etc.	60
	HDMI Setup	Makes settings for HDMI video/audio output.	63
	Audio Setup	Makes settings for audio playback.	64
	ZONE2 Setup	Makes settings for audio playback in a ZONE2 system.	65
	Option Setup	Makes various other settings.	65
Input Setup 	Language	Sets the language for display the menu on the TV screen.	67
	Auto Preset	Uses the auto preset function to program radio stations.	69
	Preset Skip	Sets the preset memories that you do not want to display when tuning.	69
	Preset Name	Assigns name to a preset memory.	69
	Input Assign	Changes input connector assignment.	70
	Video	Makes the video settings.	71
	Input Mode	Sets the audio input mode and decode mode.	72
	Rename	Changes the display name for this source.	72
	Source Level	Adjusts the playback level of the audio input.	72
	Playback Mode	Makes settings for iPod source playback.	73

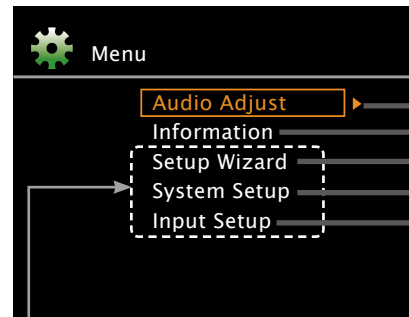

Items that only need to be set once

Set these for example upon purchase. Once these items are set, there is no need to set them again unless the speaker layout or the connected speakers have been changed.

Examples of menu screen displays

Typical examples are described below.

[Example 1] Menu selection screen (Top menu)

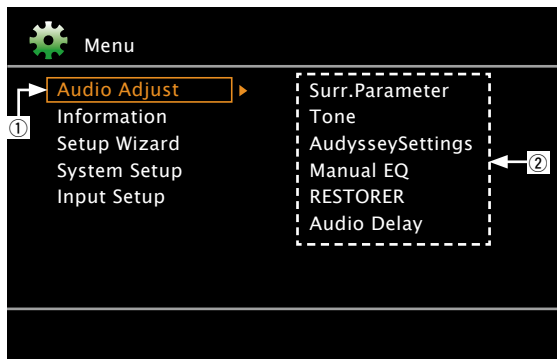

- ① Currently selected setup item
- ② List of currently selected setup subcategory

Press ▾ to select "System Setup" and then press ▷.
(Or press ENTER.)

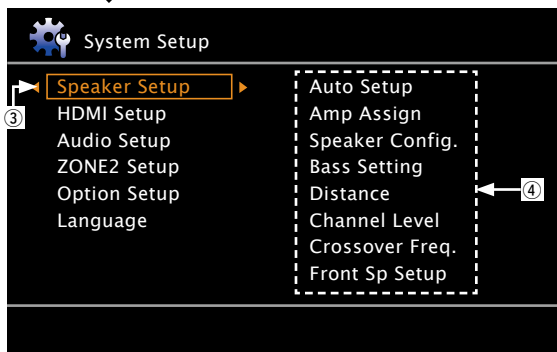

- ③ Selected setup item
- ④ Options of the selected setup item

[Example 2] Audyssey® Auto Setup screen (with illustration)

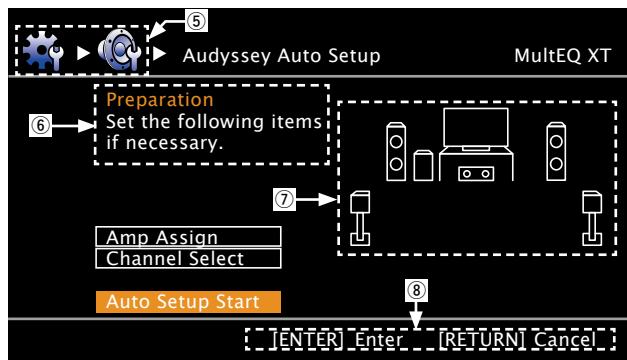

- ⑤ History icon
- ⑥ Operation guidance text
- ⑦ Illustration
- ⑧ Operation button guidance

List

Selected item

- Switch the selected item using △▽.

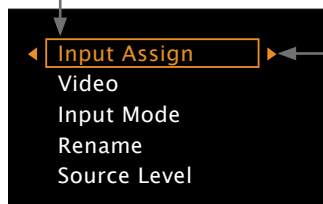

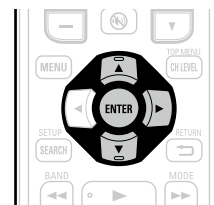

Proceed to the subcategory
(Use ▷ or ENTER to switch.)

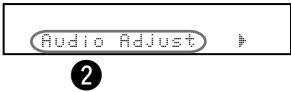
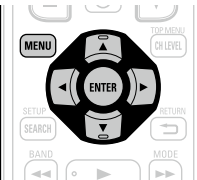
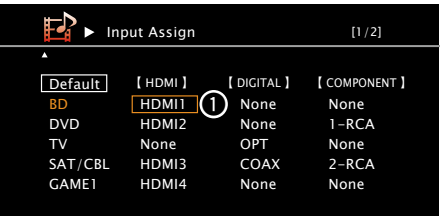
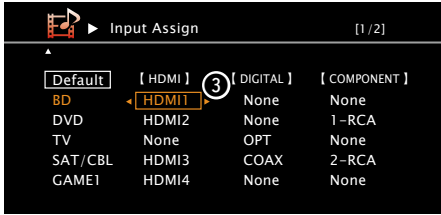
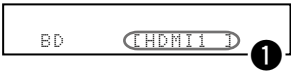

Examples of menu and front display

Below we describe typical examples of displays on the TV screen and on the set's display window.

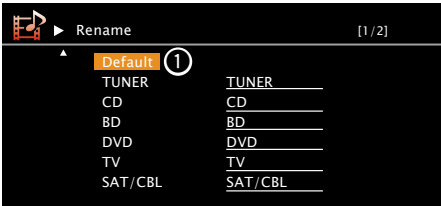
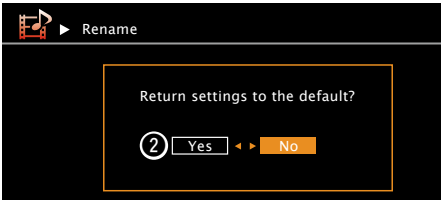
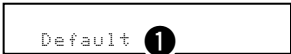
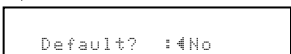
	Menu display	Front display	Description
Top menu display			<ol style="list-style-type: none"> 1 Press MENU to display the menu screen. 2 TV screen: Displays the selected line. Display: Displays the selected item. <ul style="list-style-type: none"> • Use $\Delta \nabla$ to move to the item you want to set. 
Display when changing settings	 <p>Press ENTER.</p> 	 <p>Press ENTER.</p> 	<ol style="list-style-type: none"> 1 TV screen: Displays the selected line. Display: Displays the selected item. 2 Press ENTER to set to the mode in which the setting can be made. <ul style="list-style-type: none"> • Use $\Delta \nabla$ to move to the item you want to set. <p>3 $\blacktriangle \blacktriangleleft$ is displayed at the sides of items whose setting can be changed. Use $\blacktriangleleft \blacktriangleright$ to change to the desired setting.</p>
Display when resetting	 <p>Press ENTER.</p> 	 <p>Press ENTER.</p> 	<ol style="list-style-type: none"> 1 Press Δ to select "Default", then press ENTER. 2 Press \blacktriangleleft to select "Yes", then press ENTER.

Inputting characters

You can change the names as desired using the "Preset Name" (page 69), "Rename" (page 72), "Zone Rename" (page 66), "Quick Sel.Name" (page 66). For inputting characters, there are three methods, as shown below.

Method for inputting characters

Method	Operations
Using the keyboard screen	<ul style="list-style-type: none"> Operating with the remote control unit. Select a character on the TV screen to input characters.
Using the number buttons (10 Key input screen)	<ul style="list-style-type: none"> Operating with the remote control unit. Multiple characters are assigned to a button, and each time the button is pressed, a character is switched.
Using the cursor buttons (10 Key input screen)	<ul style="list-style-type: none"> Operating with the remote control unit. Use $\Delta \nabla \triangleleft \triangleright$ and ENTER to input characters.

Keyboard screen

Display of a keyboard input screen

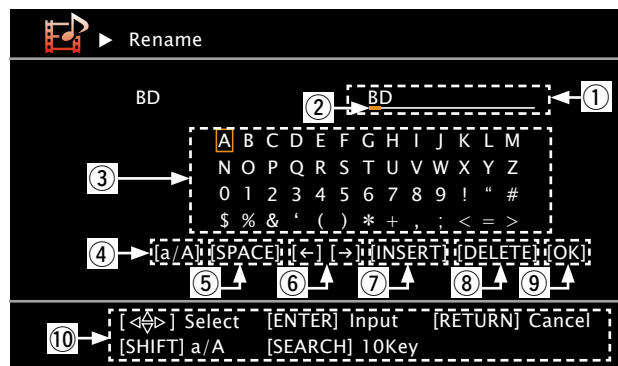

- ① Character input section (Maximum 8 characters)
- ② Cursor
- ③ Keyboard section
- ④ Uppercase and lowercase switch key
- ⑤ Space key
- ⑥ Cursor keys
- ⑦ Insert key
- ⑧ Delete key
- ⑨ OK key
- ⑩ Guide for operation buttons

Using the keyboard screen

1 Display the screen for inputting characters (page 47 "Menu map").

2 Select a character to be changed.
① Press $\Delta \nabla \triangleleft \triangleright$ to select [←] or [→].

② Press **ENTER** to place the cursor at the character to be changed.

Each time **ENTER** is pressed, the cursor moves by one character.

3 Select a character to be input with $\Delta \nabla \triangleleft \triangleright$ then press **ENTER**.

- The types of characters that can be input are as shown below.

[Upper case characters/Numbers/Symbols]
 ABCDEFGHIJKLMNOPQRSTUVWXYZ
 0123456789
 ! " # \$ % & ' () * + , ; < = >
[Lower case characters/Numbers/Symbols]
 abcdefghijklmnopqrstuvwxyz
 0123456789
 . @ - _ / : ~ ? [\] ^ ` { | }

- When you press **SHIFT** while you type in, you can change uppercase characters to lowercase and vice versa.

4 Repeat steps 2 and 3 to change the name.

5 Use $\Delta \nabla \triangleleft \triangleright$ to select [OK], then press **ENTER**.

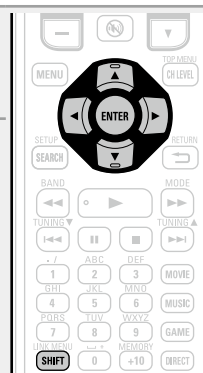

10 Key input screen

Display of a 10 Key input screen

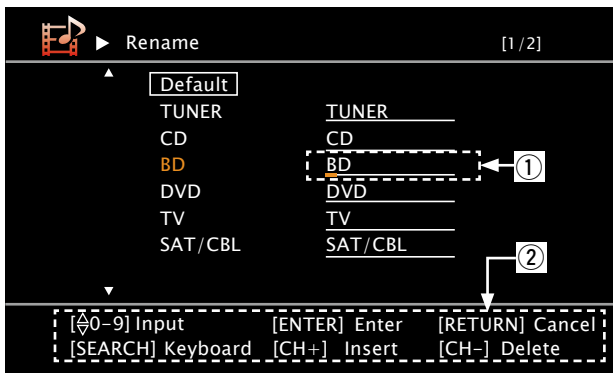

- ① Character input section (Maximum 8 characters)
- ② Guide for operation buttons

Using the number buttons

1 Display the screen for inputting characters (page 47 “Menu map”).

2 Press **SEARCH** while a keyboard screen is displayed.

A 10 Key input screen is displayed.

- When a button from **0 – 9** is pressed while the soft keyboard screen is being displayed, the screen switches to the 10 Key input screen.

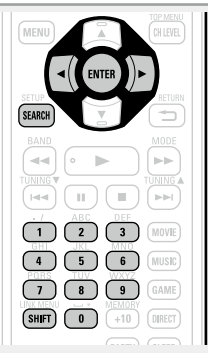

3 Place the cursor at the character to be changed with \triangleleft \triangleright and press the number button (**0 – 9**) until the desired character is displayed.

- The types of characters that can be input are as shown below.

1 1. @ - _ / : ~	6 M N O m n o 6
2 A B C a b c 2	7 P Q R S p q r s 7
3 D E F d e f 3	8 T U V t u v 8
4 G H I g h i 4	9 W X Y Z w x y z 9
5 J K L j k l 5	0 0 (Space) ! " # \$ % & ' () * + , ; < = > ? [\] ^ _ { } ~

- When you press **SHIFT** while you type in, you can change uppercase characters to lowercase and vice versa.
- For entering the characters assigned to one number button continuously, press \triangleright to move the cursor to the right after entering a character then enter the next character.
- For entering characters assigned to separate buttons, press the number button continuously. The cursor automatically moves to the next position, and the entered character is registered.

4 Repeat step 3 to change the name then press **ENTER** to register it.

Example: For changing the input source from “DVD” to “DENON”

- ① Place the cursor at “V”. D **V** D
- ② Press **3** twice. D **E** D
“V” changes to “E”.
- ③ Press **6** twice. D E **N**
“E” is automatically registered, and “D” changes to “N”.
- ④ Press \triangleright . D E N **█**
“N” is registered.
- ⑤ Press **6** three times. D E N **O**
Input “O”.
- ⑥ Press \triangleright . D E N O **█**
“O” is registered.
- ⑦ Press **6** twice. D E N O **N**
Input “N”.
- ⑧ Press **ENTER** to register the input source name.

Using the cursor buttons

1 Display the screen for inputting characters (page 47 “Menu map”).

2 Press **SEARCH** while a keyboard screen is displayed. A 10 Key screen is displayed.

3 Use \triangleleft \triangleright to set the cursor to the character you want to change.

4 Use \triangleup \triangleleft \triangleright \triangleleft to change the character, then press **ENTER**.

- The types of characters that can be input are as shown below.

[Upper case characters]
ABCDEFGHIJKLMNOPQRSTUVWXYZ

[Lower case characters]
abcdefghijklmnopqrstuvwxyz

[Symbols] ! " # \$ % & ' () * + , - . / : ; < = > ? @ [\] ^ _ ` { | } ~

[Numbers] 0123456789 (Space)

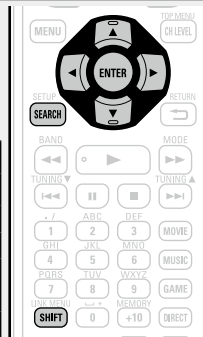

- When you press **SHIFT** while you type in, you can change uppercase characters to lowercase and vice versa.

5 Repeat steps 3 and 4 to change the name then press **ENTER** to register it.



The sound being played in the surround mode can be adjusted to your liking. The items (parameters) that can be adjusted depend on the signal being input and the currently set surround mode. For details on the adjustable parameters, see “Surround modes and surround parameters” (🔗 [page 87](#)).

NOTE

Some setting items cannot be set while playback is stopped. Make the settings during playback.

Menu operation

1 Press **ZONE SELECT** to switch the zone mode to **[M]** (MAIN ZONE).
The **[M]** indicator lights.

2 Press **AMP** to set the remote control unit to AMP-operation mode.

3 Press **MENU**.
The menu is displayed on the TV screen.

4 Use Δ / ∇ to select the menu to be set or operated.

5 Press **ENTER** or \triangleright to enter the setting.

- To return to the previous item, press **RETURN** \curvearrowright .
- Exiting the Menu, press **MENU** while the menu is displayed.
The menu display disappears.

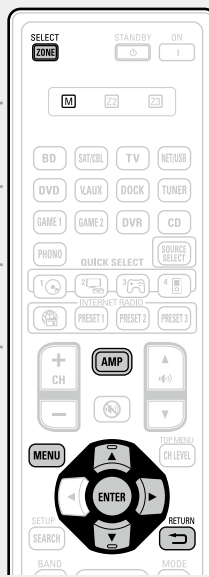

Items that can be set with the “Audio Adjust” procedure

Surr.Parameter (🔗 [page 53](#))

Tone (🔗 [page 55](#))

Audyssey Settings (🔗 [page 55](#))

Manual EQ (🔗 [page 57](#))

RESTORER (🔗 [page 57](#))

Audio Delay (🔗 [page 57](#))

Surr.Parameter



Default settings are underlined.

Adjust surround sound parameters. It may not be possible to set this item depending on the input signal (refer to page 87 “Surround modes and surround parameters”).

NOTE

- You cannot set the surround parameters in the PURE DIRECT mode.
- During playback in PURE DIRECT mode, the surround parameters are the same as in DIRECT mode.

Setting items	Setting details
Mode Set the play modes for the different surround modes.	<input type="checkbox"/> In the PLIIx or PLII mode Cinema : Surround sound mode optimized for movie sources. Music : Surround sound mode optimized for music sources. Game : Surround sound mode optimized for games. Pro Logic : Dolby Pro Logic playback mode (PLII mode only). <input type="checkbox"/> In the PLIIz mode Height : Dolby PLIIz Height playback mode. <input type="checkbox"/> In the DTS NEO:6 mode Cinema : Surround sound mode optimized for movie sources. Music : Surround sound mode optimized for music sources.  <ul style="list-style-type: none"> • When “Surr.Parameter” – “PLIIz Height” (refer to page 54) is set to “ON”, the “Height” mode is set automatically. • The “Music” mode is also effective for movie sources including a lot of stereo music.
Cinema EQ Soften the treble range of movie soundtracks for better understanding.	ON : “Cinema EQ” is used. OFF : “Cinema EQ” is not used.
DRC Compress dynamic range (difference between loud and soft sounds).	Auto : Automatic dynamic range compression on/off control according to source. This can be set in the Dolby TrueHD mode. Low / Middle / High : These set the compression level. OFF : Dynamic range compression always off.
D.Comp Compress dynamic range (difference between loud and soft sounds).	OFF : Turn dynamic range compression off. Low / Middle / High : These set the compression level.



Setting items	Setting details
LFE Adjust the low-frequency effects level (LFE).	-10dB – 0dB  For proper playback of the different sources, we recommend setting to the values below. <ul style="list-style-type: none"> • Dolby Digital sources : “0dB” • DTS movie sources : “0dB” • DTS music sources : “-10dB”
C.Image Assign center channel signal to front left and right channels for wider sound.	0.0 – 1.0 (0.3)
Panorama Assign front L/R signal also to surround channels for wider sound.	ON : Set. OFF : Do not set.
Dimension Shift sound image center to front or rear to adjust playback balance.	0 – 6 (3)
C.Width Assign center channel signal to front left and right channels for wider sound.	0 – 7 (3)
Delay Time Adjust delay time to control sound stage size.	0ms – 300ms (30ms)
Effect Level Adjust effect signal level.	1 – 15 (10)  Set to a lower level if the positioning and sense of phase of the surround signals seems unnatural.
Room Size Determine size of acoustic environment.	Small : Simulate acoustics of a small room. Medium-S : Simulate acoustics of a medium-small room. Medium : Simulate acoustics of a medium room. Medium-L : Simulate acoustics of a medium-large room. Large : Simulate acoustics of a large room. <p>NOTE</p> “Room Size” does not indicate the size of the room in which sources are played.

Setting items	Setting details
Height Gain Control the front height channel volume.	<p>Low : Reduce the front height channel volume. Middle : Front height channel sound is output with standard sound volume. High : Increase the front height channel volume.</p> <p>NOTE</p> <p>“Height Gain” is displayed for the following settings.</p> <ul style="list-style-type: none"> • When “Amp Assign” (☞ page 60) is set to “F.HEIGHT”. • When the “Speaker Config.” – “F.Height” setting (☞ page 61) is set other than to “None”. • When surround mode is “PLIIz” or the PLIIz decoder is used.
PLIIz Height Determine whether to use front height channel.	<p>ON : Audio is output from the front height speaker. OFF : Audio is not output from the front height speaker.</p> <p>NOTE</p> <ul style="list-style-type: none"> • “PLIIz Height” is displayed with the settings listed below. <ul style="list-style-type: none"> • When the “Speaker Config.” – “F.Height” setting (☞ page 61) is set to other than “None”. • “PLIIz Height” cannot be set if the HD Audio source being played includes a front height channel. In this case, the Front height channel is played back without decoding in PLIIz mode, using the input signal.
AFDM (Auto flag detect mode) Detect the source’s surround back channel signal and set the optimum surround mode automatically.	<p>ON : Set. OFF : Do not set.</p> <p>[Example] Playing Dolby Digital software (with EX flag)</p> <ul style="list-style-type: none"> • When “AFDM” is set to “ON”, the surround mode is automatically set to the DOLBY D + PLIIx C mode. • To play in the DOLBY DIGITAL EX mode, set “AFDM” to “OFF” and “Surr.Parameter” – “S.Back” to “MTRX ON”. <p>☞ Some Dolby Digital EX sources do not include EX flags. If the playback mode does not switch automatically even when “AFDM” is set to “ON”, set “Surr.Parameter” – “S.Back” to “MTRX ON” or “PLIIx C”.</p>

Setting items	Setting details
S.Back Sets the method of generating of the surround back channel.	<p><input type="checkbox"/> For 2-channel sources ON : The surround back channel is used. OFF : No signal is played from the surround back channels.</p> <p><input type="checkbox"/> For multi-channel sources Set the decoding method for the surround back channel. ON*1 : Convert the 5.1-channel source of the DTS/DTS-HD input signals to the 7.1-channel output recommended by DTS and then play. MTRX ON : Generate and play the surround back channel signals from the surround channel signals by means of the Dolby Digital EX decoder. ES MTRX*2 : Generate and play the surround back channel signals from the surround channel signals of the DTS source by means of the DTS-ES decoder. PLIIx C*3 : Generate and play the surround back signals by decoding the signals in the Dolby Pro Logic IIx Cinema mode. PLIIx M : Generate and play the surround back signals by decoding the signals in the Dolby Pro Logic IIx Music mode. OFF : Do not play the surround back channel.</p> <p>*1 This can be selected when playing the 5.1-channel source of DTS/DTS-HD. *2 This can be selected when playing DTS sources. *3 This can be selected when “Speaker Config.” – “S.Back” (☞ page 60) is set to “2spkrs”.</p> <p>☞ If the source being played contains a surround back signal, the decoder type is automatically selected by the AFDM function. Set “AFDM” to “OFF” to switch to your preferred decoder.</p> <p>NOTE</p> <p>If the setting in “Speaker Config.” – “S.Back” (☞ page 60) is “None”, “S.Back” is not displayed.</p>
Subwoofer Turn subwoofer output on and off.	<p>ON : The subwoofer is used. OFF : The subwoofer is not used.</p> <p>NOTE</p> <p>This can be set when the surround mode is “DIRECT” (☞ page 27) and the “Subwoofer Mode” (☞ page 61) is “LFE+Main”.</p>
Default The “Surr.Parameter” settings are returned to the default settings.	<p>Yes : Reset to the defaults. No : Do not reset to the defaults.</p> <p>☞ When you select “Default” and press ENTER, the “Return settings to the default?” prompt is displayed. Select either “Yes” or “No”, and press ENTER.</p> 

Tone

Adjust the tonal quality of the sound.

Setting items	Setting details
Tone Control Set the tone control function to ON and OFF.	ON : Allow tone adjustment (bass, treble). OFF : Playback without tone adjustment.  "Tone Control" can be set when "Dynamic EQ®" (page 56) is set to "OFF". <div style="background-color: #f08080; padding: 2px; display: inline-block; margin-top: 5px;">NOTE</div> <ul style="list-style-type: none"> "Tone Control" settings are not reflected to ZONE2. The tone cannot be adjusted in the "DIRECT" mode.
Bass Adjust low frequency range (bass).	-6dB – +6dB  "Bass" can be set when "Tone Control" is set to "ON".
Treble Adjust high frequency range (treble).	-6dB – +6dB  "Treble" can be set when "Tone Control" is set to "ON".



Audyssey Settings

Default settings are underlined.

Set Audyssey MultEQ® XT, Audyssey Dynamic EQ® and Audyssey Dynamic Volume®. These can be selected after Audyssey® Auto Setup has been performed. For additional information on Audyssey technology, please see [page 92](#).





NOTE



- If you have not performed Auto Setup, or if you change the speaker settings after performing Auto Setup, you may not be able to select Dynamic EQ®/Dynamic Volume®. In this case, either perform Audyssey® Auto Setup over again or perform "Restore" ([page 19](#)) to return to the settings after Audyssey® Auto Setup was run.
- When HD Audio for which the sampling frequency exceeds 96 kHz is played back, the "Audyssey Settings" cannot be set.

Setting items	Setting details
MultEQ® XT MultEQ® XT corrects both time and frequency response problems in the listening area based on Audyssey® Auto Setup calibration. We recommend "Audyssey". MultEQ® XT is the prerequisite function for Dynamic EQ® and Dynamic Volume®.	Audyssey : Optimize the frequency response of all speakers. Audyssey Byp.L/R : Optimize frequency response of speakers except front L and R speakers. Audyssey Flat : Optimize frequency response of all speakers to flat response. Manual : Apply frequency response set with "Manual EQ" (page 57). OFF : Turn "MultEQ® XT" equalizer off.  <ul style="list-style-type: none"> "Audyssey", "Audyssey Byp. L/R" and "Audyssey Flat" can be selected after Audyssey® Auto Setup has been performed. "Audyssey" is automatically selected after performing Audyssey® Auto Setup. When "Audyssey", "Audyssey Byp. L/R" or "Audyssey Flat" is selected,  illuminates. After running Audyssey® Auto Setup, if the Speaker Configuration, Distance, Channel Level, and Crossover Frequency have changed without increasing the number of speakers measured, only  illuminates. <div style="background-color: #f08080; padding: 2px; display: inline-block; margin-top: 5px;">NOTE</div> <ul style="list-style-type: none"> "MultEQ® XT" and "Manual" cannot be selected when "EQ Customize" is set to "Not Used" (page 64). When using headphones, "MultEQ® XT" is automatically set to "OFF".



"MultEQ® XT", "Dynamic EQ®" and "Dynamic Volume®" settings are stored for each input source.



Setting items	Setting details
<p>Dynamic EQ® Solve the problem of deteriorating sound quality as volume is decreased by taking into account human perception and room acoustics. Works with MultEQ® XT.</p>	<p>ON : Use Dynamic EQ®. OFF : Do not use Dynamic EQ®.</p> <p>  or  is displayed when set to "ON".</p>
<p>Reference Offset Audyssey Dynamic EQ® is referenced to the standard film mix level. It makes adjustments to maintain the reference response and surround envelopment when the volume is turned down from 0 dB. However, film reference level is not always used in music or other non-film content. Dynamic EQ® Reference Level Offset provides three offsets from the film level reference (5 dB, 10 dB, and 15 dB) that can be selected when the mix level of the content is not within the standard.</p>	<p>0dB (Film Ref) : This is the default setting and should be used when listening to movies. 5dB : Select this setting for content that has a very wide dynamic range, such as classical music. 10dB : Select this setting for jazz or other music that has a wider dynamic range. This setting should also be selected for TV content as that is usually mixed at 10 dB below film reference. 15dB : Select this setting for pop/rock music or other program material that is mixed at very high listening levels and has a compressed dynamic range.</p> <p> Setting is enabled when "Dynamic EQ®" is "ON" (page 56).</p>

Setting items	Setting details
<p>Dynamic Volume® Solve the problem of large variations in volume level between TV, movies and other content (between quiet passages and loud passages, etc.) by automatically adjusting to the user's preferred volume setting.</p>	<p>Midnight : Most adjustment to loudest and softest sounds. Evening : Medium adjustment to loudest and softest sound. Day : Least adjustment to loudest and softest sounds. OFF : Do not use "Dynamic Volume®".</p> <p>  is displayed when set to "Midnight", "Evening" or "Day".</p> <ul style="list-style-type: none"> If "Dynamic Volume®" is set to "Yes" in Auto Setup (page 17), the setting is automatically changed to "Evening".

Manual EQ

Default settings are underlined.

Use the graphic equalizer to adjust the tone of each speaker.
 "Manual EQ" can be set when "MultEQ® XT" setting ([page 55](#)) is "Manual".

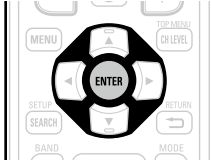
Setting items	Setting details
Adjust Channel Correct the tone of each speaker.	① Select the speaker tone adjustment method. All : Adjust the tone of all speakers together. L/R : Adjust the tone of left and right speakers together. Each : Adjust the tone of each speaker. ② Select the speaker. ③ Select the adjustment frequency band. 63Hz / 125Hz / 250Hz / 500Hz / 1kHz / 2kHz / 4kHz / 8kHz / 16kHz • Select the speakers you want to adjust when "L/R" or "Each" is selected. ④ Adjust the level. -20.0dB – +6.0dB (0.0dB)
Curve Copy Copy "Audyssey Flat" curve from MultEQ® XT.	Yes : Copy. No : Do not copy.  <ul style="list-style-type: none"> "Curve Copy" is displayed after Audyssey® Auto Setup has been performed. When you select "Curve Copy" and press ENTER, the "Set EQ curve to Audyssey Flat?" prompt is displayed. Select either "Yes" or "No", and press ENTER.
Default The "Manual EQ" settings are returned to the default settings.	Yes : Reset to the defaults. No : Do not reset to the defaults.  When you select "Default" and press ENTER , the "Return settings to the default?" prompt is displayed. Select either "Yes" or "No", and press ENTER . 

RESTORER

Compressed audio formats such as MP3, WMA (Windows Media Audio) and MPEG-4 AAC reduce the amount of data by eliminating signal components that are hard for the human ear to hear. The RESTORER function generates the signals eliminated upon compression, restoring the sound to conditions near those of the original sound before compression. It also corrects the sense of volume of the bass to obtain richer sound with compressed audio signals.

Setting details

OFF : Do not use RESTORER.

Mode1 (RESTORER 64) : Optimized mode for compressed sources with very weak highs.

Mode2 (RESTORER 96) : Apply suitable bass and treble boost for all compressed sources.

Mode3 (RESTORER HQ) : Optimized mode for compressed sources with normal highs.



- This item can be set with analog signals or PCM signal (fs = 44.1/48 kHz) is input.
- "RESTORER" settings are stored for each input source.
- This item default setting for "iPod" is "Mode3". All others are set to "OFF".
- When set to something other than "OFF", **RSTR** is displayed.
- This cannot be set when the surround mode is set to "DIRECT" or "PURE DIRECT".

Audio Delay

Default settings are underlined.

While viewing video, manually adjust the time to delay audio output.

Setting details

0ms – 200ms



- This item can be set within the range of 0 to 100 ms when "Auto Lip Sync" ([page 63](#)) is set to "ON" and when a TV compatible with Auto Lip Sync is connected.
- Store "Audio Delay" for each input source.
- Audio Delay for game mode can be set when "Video Mode" ([page 71](#)) is set to "Auto" or "Game".



Show information about receiver settings, input signals, etc.

Items	Setting details	
Status Show information about current settings.	<input type="checkbox"/> MAIN ZONE This item shows information about settings for MAIN ZONE. The information displayed differs according to the input source. Select Source / Name / Surround Mode / Input Mode / Decode Mode / Assign / Video Select / Video Mode / Content Type etc.	
	<input type="checkbox"/> ZONE2 This item shows information about settings for ZONE2. Power / Select Source / Volume Level "Status" for ZONE2 is displayed when "Amp Assign" is set to "ZONE2".	
Audio Signal Show information about audio input signals.	Surround Mode : The currently set surround mode. Signal : The input signal type. fs : The input signal's sampling frequency. Format : The number of channels in the input signal (front, surround, LFE). Offset : The dialogue normalization correction value. Flag : This is displayed when inputting signals including a surround back channel. "MATRIX" is displayed with Dolby Digital EX and DTS-ES Matrix signals, "DISCRETE" with DTS-ES Discrete signals.	
	<table border="1" style="width: 100%;"> <thead> <tr> <th style="text-align: center;">Dialogue normalization function</th> </tr> </thead> <tbody> <tr> <td> This function is automatically activated when playing Dolby Digital sources. It automatically corrects the standard signal level for individual program sources. The correction value can be checked using the STATUS on the main unit. <div style="border: 1px solid black; padding: 5px; margin: 10px auto; width: fit-content;"> Offset - 4dB </div> The figure is the corrected value. This cannot be changed. </td> </tr> </tbody> </table>	Dialogue normalization function
Dialogue normalization function		
This function is automatically activated when playing Dolby Digital sources. It automatically corrects the standard signal level for individual program sources. The correction value can be checked using the STATUS on the main unit. <div style="border: 1px solid black; padding: 5px; margin: 10px auto; width: fit-content;"> Offset - 4dB </div> The figure is the corrected value. This cannot be changed.		
HDMI Information Show information about HDMI input/output signals and monitor.	Signal Info. • Resolution / Color Space / Pixel Depth	
	Monitor Info. • Interface / Support Resolution	

Items	Setting details
Auto Surround Show information about auto surround mode settings.	Analog/PCM 2ch / Digital 2ch / Digital 5.1ch / Multi ch
Quick Select Show information about "Quick select function" (page 44) settings.	Quick Select 1 / Quick Select 2 / Quick Select 3 / Quick Select 4 / ZONE2 Quick Select 1 / ZONE2 Quick Select 2 / ZONE2 Quick Select 3 / ZONE2 Quick Select 4 • Name / Volume Level / Select Source / Video Select / MultEQ® XT / Dynamic EQ® / Dynamic Volume® / Auto Surround Mode Analog/PCM 2ch / Auto Surround Mode Digital 2ch / Auto Surround Mode Digital 5.1ch / Auto Surround Mode Multi ch "ZONE2 Quick Select" is displayed when "Amp Assign" is set to "ZONE2".
Preset Channel Show information about preset channels.	A1 – G8
<div style="border: 1px solid black; padding: 2px; display: inline-block;">TUNER</div>	



Set when changing Audyssey® Auto Setup settings, or when changing the audio, video, display or other settings.

- If you change the speaker settings after performing Audyssey® Auto Setup, it will not be possible to set Audyssey MultEQ® XT, Audyssey Dynamic EQ® and Audyssey Dynamic Volume® (page 55, 56).
- Can be used without changing the settings. Please set if necessary.

Menu operation

- 1 Press ZONE SELECT** to switch the zone mode to **M** (MAIN ZONE).
The **M** indicator lights.
- 2 Press AMP** to set the remote control unit to AMP-operation mode.
- 3 Press MENU.**
The menu is displayed on the TV screen.
- 4 Press Δ / ∇** to select the menu to be set or operated.
- 5 Press ENTER or \triangleright** to enter the setting.

- To return to the previous item, press **RETURN** \leftarrow .
- Exiting the Menu, press **MENU** while the menu is displayed.
The menu display disappears.

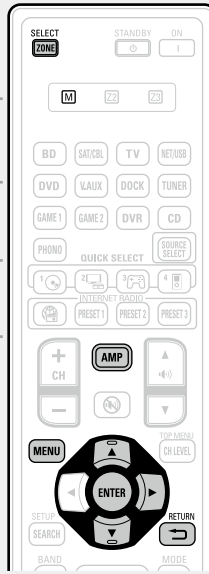

Items that can be set with the "System Setup" procedure

Speaker Setup (page 60)

HDMI Setup (page 63)

Audio Setup (page 64)

ZONE2 Setup (page 65)

Option Setup (page 65)

Language (page 67)



Speaker Setup

Default settings are underlined.



Perform when setting the speakers manually or when changing settings made in Audyssey® Auto Setup.



- If you change the speaker settings after performing Audyssey® Auto Setup, it will not be possible to select Audyssey MultEQ® XT, Audyssey Dynamic EQ® and Audyssey Dynamic Volume® ([page 55, 56](#)).
- "System Setup" can be used without changing the settings. Please set if necessary.

Setting items	Setting details
Amp Assign The signal output from the SURR.BACK/AMP ASSIGN speaker terminal of this unit can be switched to match your speaker environment.	NORMAL : Select the "NORMAL" setting to perform 7.1-channel playback using the surround back. ZONE2 : Select the "ZONE2" setting to assign the unit's built-in power amplifier for ZONE2 and output the audio in stereo. Bi-AMP : Select the "Bi-AMP" setting to connect the front speakers via the bi-amp connection. Front B : Select the "Front B" setting to use the second set of front speakers for playback. You can switch the front speakers A and B to be used for playback in accordance with the 2-channel playback or multi-channel playback mode. When you select this Front B setting, also perform the "Front Sp Setup" (page 62) procedure. F.HEIGHT : Select the "F.HEIGHT" setting to use the front height speaker for playback.
Speaker Config. Select speaker configuration and size (bass reproduction capability). <div style="background-color: #f08080; border-radius: 5px; padding: 2px; display: inline-block; margin-top: 10px;">NOTE</div> Do not use the outward shape of the speaker to determine selection of a "Large" or "Small" speaker. Instead, use the frequencies set in "Crossover Freq." (page 62) as the standard for determining bass reproduction capability.	Front : Set the front speaker size. <ul style="list-style-type: none"> • Large : Use a large speaker that can adequately play back low frequencies. • Small : Use a small speaker that has inadequate playback capacity for low frequencies. <ul style="list-style-type: none"> • When "Subwoofer" is set to "No", "Front" is automatically set to "Large". • When "Front" is set to "Small", "Center", "Surround", "S.Back" and "F.Height" can not be set to "Large". <hr/> Center : Set the presence and size of the center speaker. <ul style="list-style-type: none"> • Large : Use a large speaker that can adequately play back low frequencies. • Small : Use a small speaker that has inadequate playback capacity for low frequencies. • None : Select when a center speaker is not connected. <ul style="list-style-type: none"> • "Large" is not displayed when "Front" is set to "Small".

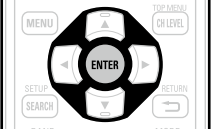
Setting items	Setting details
Speaker Config. (Continued)	Subwoofer : Set the presence of a subwoofer. <ul style="list-style-type: none"> • Yes : Use a subwoofer. • No : Select when a subwoofer is not connected. When "Front" is set to "Small", "Subwoofer" is automatically set to "Yes".
	Surround : Set the presence and size of the surround speakers. <ul style="list-style-type: none"> • Large : Use a large speaker that can adequately play back low frequencies. • Small : Use a small speaker that has inadequate playback capacity for low frequencies. • None : Select when the surround speakers are not connected. <ul style="list-style-type: none"> • When "Surround" is set to "Large", "S.Back" and "F.Height" can be set to "Large". • When "Surround" is set to "None", "S.Back" and "F.Height" are automatically set to "None".
	S.Back : Set the presence, size and number of surround back speakers. <ul style="list-style-type: none"> • Large : Use a large speaker that can adequately play back low frequencies. • Small : Use a small speaker that has inadequate playback capacity for low frequencies. • None : Select when the surround back speakers are not connected. <ul style="list-style-type: none"> • 2spkrs : Use two surround back speakers. • 1spkr : Use only one surround back speaker. When you select this setting, connect the surround back speaker to the left (L) channel. Even when the "S.Back" setting is other than "None", sound may not be emitted from the surround back speaker, depending on the playback source. In this case, make "Surr.Parameter" – "S.Back" setting other than "OFF" (page 54).
	<div style="background-color: #f08080; border-radius: 5px; padding: 2px; display: inline-block; margin-top: 10px;">NOTE</div> When "Amp Assign" setting (page 60) is "NORMAL", you can make the "S.Back" setting.

Setting items	Setting details
Speaker Config. (Continued)	<p>F.Height : Set the presence and size of the front height speakers.</p> <ul style="list-style-type: none"> • Large : Use a large speaker that can adequately play back low frequencies. • Small : Use a small speaker that has inadequate playback capacity for low frequencies. • None : Select when the front height speakers are not connected. <p>NOTE</p> <p>When “Amp Assign” setting (page 60) is “F.HEIGHT”, you can make the “F.Height” setting.</p>
Bass Setting Set subwoofer and LFE signal range playback.	<p>Subwoofer Mode : Select low range signals to be reproduced by subwoofer.</p> <ul style="list-style-type: none"> • LFE : The low range signal of the channel set to “Small” speaker size is added to the LFE signal output from the subwoofer. • LFE+Main : The low range signal of all channels is added to the LFE signal output from the subwoofer. <p></p> <ul style="list-style-type: none"> • “Subwoofer Mode” can be set when “Speaker Config.” – “Subwoofer” (page 60) is set to “Yes”. • Play music or a movie source and select the mode offering the strongest bass. • Select “LFE+Main” if you want the bass signals to always be produced from the subwoofer. <p>NOTE</p> <p>If “Front” and “Center” for “Speaker Config.” are set to “Large”, and “Subwoofer Mode” is set to “LFE”, no sound may be output from the subwoofers, depending on the input signal or selected surround mode.</p> <p>LPF for LFE : Set LFE signal playback range. Set this when you want to change the playback frequency of the subwoofer.</p> <p>• 80Hz / 90Hz / 100Hz / 110Hz / 120Hz / 150Hz / 200Hz / 250Hz</p>

Setting items	Setting details
Distance Set distance from listening position to speakers. Measure beforehand the distance from the listening position to each speaker.	<p>Unit : Set the unit of distance.</p> <ul style="list-style-type: none"> • Feet / Meters <p>Step : Set the minimum variable width of the distance.</p> <ul style="list-style-type: none"> • 1ft / 0.1ft • 0.1m / 0.01m <p>Default : The “Distance” settings are returned to the default settings.</p> <ul style="list-style-type: none"> • Yes : Reset to the defaults. • No : Do not reset to the defaults. <p> When you select “Default” and press ENTER, the “Return settings to the default?” prompt is displayed. Select either “Yes” or “No”, and press ENTER.</p>  <p>Front L / Front R / Center / Subwoofer / Surround L / Surround R / S.Back L* / S.Back R* / F.Height L / F.Height R : Select the speaker.</p> <p>* When the “Speaker Config.” – “S.Back” setting (page 60) is set to “1spkr”, “S.Back” is displayed.</p> <ul style="list-style-type: none"> • 0.0ft – 60.0ft / 0.00m – 18.00m : Set the distance. <p></p> <ul style="list-style-type: none"> • The speakers that can be selected differ depending on the “Amp Assign” (page 60) and “Speaker Config.” (page 60) settings. • Default settings : Front L / Front R / Center / Subwoofer / F.Height L / F.Height R : 12.0 ft (3.60 m) Surround L / Surround R / S.Back L / S.Back R : 10.0 ft (3.00 m) • Set the difference in the distance between the speakers to less than 20.0 ft (6.00 m). <p>NOTE</p> <p>Speakers set to “None” in “Speaker Config.” (page 60) are not displayed.</p>

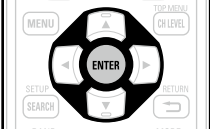

Setting items	Setting details
Channel Level Set the volume of the test tone to be the same when it is output from each speaker.	<p>Test Tone Start : Output test tone.</p> <ul style="list-style-type: none"> • Front L / F.Height L / Center / F.Height R / Front R / Surround R / S.Back R* / S.Back L* / Surround L / Subwoofer : Select the speaker. * When the "Speaker Config." – "S.Back" setting (page 60) is set to "1spkr", "S.Back" is displayed. <ul style="list-style-type: none"> • -12.0dB – +12.0dB (0.0dB) : Adjust the volume. <p></p> <p>When "Channel Level" is adjusted, the adjusted values are set for all the surround modes. To adjust the channel level separately for the different surround modes, use the operation see page 43.</p> <p>NOTE</p> <ul style="list-style-type: none"> • Speakers set to "None" in the "Speaker Config." (page 60) settings are not displayed. • When a headphones jack is inserted in the PHONES jack of this unit, the "Channel Level" is not displayed. <p>Default : The "Channel Level" settings are returned to the default settings.</p> <ul style="list-style-type: none"> • Yes : Reset to the defaults. • No : Do not reset to the defaults. <p> When you select "Default" and press ENTER, the "Return settings to the default?" prompt is displayed. Select either "Yes" or "No", and press ENTER.</p> 



Setting items	Setting details
Crossover Freq. Set the maximum frequency of the bass signal output from each channel to the subwoofer. Set the Crossover Frequency to suit the bass reproduction capability of the speaker being used.	<p>Crossover : Set the crossover frequency.</p> <ul style="list-style-type: none"> • 40Hz / 60Hz / 80Hz / 90Hz / 100Hz / 110Hz / 120Hz / 150Hz / 200Hz / 250Hz <p>Advanced : Specify crossover frequency for each speaker.</p> <ul style="list-style-type: none"> • Front / Center / Surround / S.Back / F.Height : Select the speaker. • 40Hz / 60Hz / 80Hz / 90Hz / 100Hz / 110Hz / 120Hz / 150Hz / 200Hz / 250Hz : Set the crossover frequency. <p></p> <ul style="list-style-type: none"> • "Crossover Freq." can be set when the "Bass Setting" – "Subwoofer Mode" (page 61) setting is "LFE+Main", or when you have a speaker that is set to "Small". • Always set the crossover frequency to "80Hz". When using small speakers, however, we recommend setting the crossover frequency to a higher frequency. • For speakers set to "Small", sound below the crossover frequency is cut from the sound output. The cut bass sound is output from the subwoofer or front speakers. • The speakers that can be set when "Advanced" is selected differ depending on to the "Subwoofer Mode" setting (page 61). • When "LFE" is selected, speakers set to "Small" at "Speaker Config." can be set. If the speakers are set to "Large", "Full Band" is displayed and the setting cannot be made. • If set to "LFE+Main", this setting can be made regardless of the speaker size.
Front Sp Setup Set the front speakers to use for every surround mode.	<p>2CH DIRECT/STEREO : The front speakers used in the direct, stereo and pure direct play modes (2 channel) are set in advance.</p> <ul style="list-style-type: none"> • A : Front speaker A is used. • B : Front speaker B is used. • A+B : Both front speakers A and B are used. <p>NOTE</p> <p>This can be set when "Amp Assign" is set to "Front B" (page 60).</p> <p>MULTI CH : The front speakers used in modes other than the direct, stereo and pure direct play modes (2 channel) are set in advance.</p> <ul style="list-style-type: none"> • A : Front speaker A is used. • B : Front speaker B is used. • A+B : Both front speakers A and B are used.

HDMI Setup

Default settings are underlined.

Make settings for HDMI video/audio output.

Setting items	Setting details
Auto Lip Sync Make automatic compensation for timing shift in audio and video output.	ON : Compensated. OFF : Not compensated.
HDMI Audio Out Select HDMI audio output device.	AMP : Play back through speakers connected to the unit. TV : Play back through TV connected to the unit.  <ul style="list-style-type: none"> The audio signal input from the HDMI input connector can be output as an output signal from the HDMI output connector by setting the HDMI audio output destination to TV. Audio signals input via the Analog/Coaxial/Optical input connectors cannot be output from the HDMI output connector. When the HDMI control function is activated, priority is given to the TV audio setting (page 41 "HDMI control function").
HDMI Control You can link operations with devices connected to HDMI and compatible with HDMI Control.	ON : Use HDMI control function. OFF : Do not use HDMI control function.  <ul style="list-style-type: none"> When a device that is not compatible with the HDMI control function is connected, set "HDMI Control" to "OFF". Please consult the operating instructions for each connected device to check the settings. Refer to "HDMI control function" (page 41) for more information about the HDMI control function. <p>NOTE</p> <ul style="list-style-type: none"> When "HDMI Control" is set to "ON", it consumes more standby power. If you are not using this unit for an extended period, it is recommended that you unplug the power cord from the power outlet. "HDMI Control" does not work when the power to the device is off. Either turn power on or set to standby. The HDMI control function controls operations of a TV that is compatible with the HDMI control function. Make sure that the TV and HDMI are connected when you perform HDMI control. If the "HDMI Control" settings have been changed, always reset the power to connected devices after the change.

Setting items	Setting details
Standby Source Sets the HDMI input source to put into standby when the power is on.	Last : This item is set at the last-used input source. HDMI1 / HDMI2 / HDMI3 / HDMI4 / HDMI5 / HDMI6 : Put the respective input source into standby.  "Standby Source" can be set when "HDMI Control" is set to "ON".
P.Off Control Links the power standby of this unit to external devices.	All : If power to a connected TV is turned off independently of the input source, power to this unit is automatically set to standby. Video : If power to a connected TV is turned off when the input source is BD / DVD / TV / SAT/CBL / DOCK / GAME1 / GAME2 / V.AUX, power to this unit is automatically set to standby. OFF : This unit does not link with power to a TV.  "P.Off Control" can be set when "HDMI Control" is set to "ON".



Audio Setup

Default settings are underlined.

Make settings for audio playback.

Setting items	Setting details
2ch Direct/Stereo Select the method for setting the speakers used in the 2-channel direct and stereo playback modes.	<p>Setting : Select the method for setting the speakers used in the 2-channel direct and stereo playback modes.</p> <ul style="list-style-type: none"> • Basic : The settings at "Speaker Setup" (page 60) are applied. • Custom : Make separate settings for 2-channel. Make the following settings: <hr/> <p>Front : Set the front speaker size.</p> <ul style="list-style-type: none"> • Large : Use a large speaker that can adequately play back low frequencies. • Small : Use a small speaker that has inadequate playback capacity for low frequencies. <p> If "Speaker Config." – "Subwoofer" (page 60) is set to "No", the setting is automatically set to "Large".</p> <hr/> <p>Subwoofer : Set the presence of a subwoofer.</p> <ul style="list-style-type: none"> • Yes : Use a subwoofer. • No : Select when a subwoofer is not connected. <p> If "Speaker Config." – "Subwoofer" (page 60) is set to "No", the setting is automatically set to "No". If the "Front" setting is "Small", the setting is automatically "Yes".</p> <hr/> <p>Subwoofer Mode : Select low range signals to be reproduced by subwoofer.</p> <ul style="list-style-type: none"> • LFE : When the "2ch Direct/Stereo" – "Front" setting is set to "Large", the LFE signal alone is output from the subwoofer. Also, when the "2ch Direct/Stereo" – "Front" setting is set to "Small", the front channel low range signal is added to the LFE signal output from the subwoofer. • LFE+Main : The front channel low range signal is added to the LFE signal output from the subwoofer. <p> This setting can be set made "2ch Direct/Stereo" – "SW" is set to "Yes".</p> <hr/> <p>Crossover : Set the maximum frequency of the bass signal output from each channel to the subwoofer.</p> <ul style="list-style-type: none"> • 40Hz / 60Hz / <u>80Hz</u> / 90Hz / 100Hz / 110Hz / 120Hz / 150Hz / 200Hz / 250Hz <p></p> <ul style="list-style-type: none"> • This setting can be set made "2ch Direct/Stereo" – "SW" is set to "Yes". • If the "2ch Direct/Stereo" – "Front" setting is "Large" and the "SW Mode" setting is "LFE", "Full Band" is displayed and the setting cannot be made.



Setting items	Setting details
2ch Direct/Stereo (Continued)	<p>Distance FL / Distance FR : Select the speaker.</p> <ul style="list-style-type: none"> • 0.0ft – 60.0ft (<u>12.0ft</u>) / 0.00m – 18.00m (<u>3.60m</u>) : Set the distance to the speaker. <p> Set the difference in the distance between the speakers to less than 20.0 ft (6.00 m).</p> <hr/> <p>Level FL / Level FR : Select the speaker.</p> <ul style="list-style-type: none"> • -12.0dB – +12.0dB (<u>0.0dB</u>) : Adjust the level of each channel.
Auto Surround Make setting for memorizing surround mode setting for each input signal type.	<p>ON : Memorize settings. Automatically play with the last used surround mode.</p> <p>OFF : Do not memorize settings. Surround mode does not change according to input signal.</p> <p></p> <ul style="list-style-type: none"> • The auto surround mode function lets you store in the memory the surround mode last used for playing the four types of input signals listed below. <ol style="list-style-type: none"> ① Analog and PCM 2-channel signals ② Dolby Digital and DTS 2-channel signals ③ Dolby Digital and DTS multi-channel signals ④ LPCM Multi-channel signals • When playing in PURE DIRECT, the surround mode does not change even if the input signal is changed.
EQ Customize Set the disengaged equalizers to not display when the "MultEQ [®] XT" is selected.	<p>Manual : Set when not using the "Manual" equalizer.</p> <ul style="list-style-type: none"> • Used : Use. • Not Used : Do not use. <hr/> <p>Audyssey Flat : Set when not using "Audyssey Flat" equalizer.</p> <ul style="list-style-type: none"> • Used : Use. • Not Used : Do not use. <p> Set so that "Audyssey Flat" settings can be made when Audyssey[®] Auto Setup is performed.</p> <hr/> <p>Audyssey Byp. L/R : Set when not using "Audyssey Byp. L/R" equalizer.</p> <ul style="list-style-type: none"> • Used : Use. • Not Used : Do not use. <p> Set so that "Audyssey Byp. L/R" settings can be made when Audyssey[®] Auto Setup is performed.</p>

ZONE2 Setup

Default settings are underlined.

Set the audio to play back with multi-zone (ZONE2).

“ZONE2 Setup” is displayed when “ZONE2” is selected with “Amp Assign”.

Setting items	Setting details
Lch Level Adjust the left channel output level.	-12dB – +12dB (0dB)
Rch Level Adjust the right channel output level.	-12dB – +12dB (0dB)
Volume Limit Make a setting for maximum volume.	OFF : Do not set a maximum volume. -20dB (61) / -10dB (71) / 0dB (81)  This is displayed from 0 to 99 when “Volume Display” (page 65) is set to “Absolute”.
Power On Level Define the volume setting that is active when the power is turned on.	Last : Use the memorized setting from the last session. --- (0) : Always mute when power is turned on. -80dB – 18dB (1 – 99) : The volume is adjusted to the set level.  This is displayed from 0 to 99 when “Volume Display” (page 65) is set to “Absolute”.
Mute Level Set the amount of attenuation when muting is on.	Full : The sound is muted entirely. -40dB : The sound is attenuated by 40 dB down. -20dB : The sound is attenuated by 20 dB down.







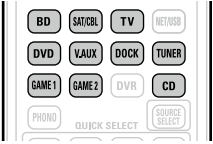

Option Setup

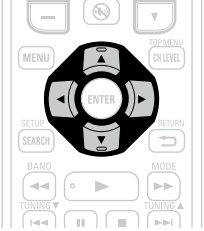
Default settings are underlined.

Make various other settings.

Setting items	Setting details
Volume Control Set the MAIN ZONE (room where the unit is located) volume setting.	Volume Display : Set how volume is displayed. <ul style="list-style-type: none"> • Relative : Display -dB (Min), in the range -80.5 dB to 18 dB. • Absolute : Display in the range 0 (Min) to 99.  <ul style="list-style-type: none"> • The “Volume Display” setting is applied also to the “Volume Limit” and “Power On Level” display method. • The “Volume Display” setting applies to all zones. Volume Limit : Make a setting for maximum volume. <ul style="list-style-type: none"> • OFF : Do not set a maximum volume. • -20dB (61) / -10dB (71) / 0dB (81) Power On Level : Define the volume setting that is active when the power is turned on. <ul style="list-style-type: none"> • Last : Use the memorized setting from the last session. • --- (0) : Always use the muting on condition when power is turned on. • -80dB – 18dB (1 – 99) : The volume is adjusted to the set level. Mute Level : Set the amount of attenuation when muting is on. <ul style="list-style-type: none"> • Full : The sound is muted entirely. • -40dB : The sound is attenuated by 40 dB down. • -20dB : The sound is attenuated by 20 dB down.
Source Delete Remove from the display input sources that are not used.	TUNER / CD / BD / DVD / TV / SAT/CBL / GAME1 / GAME2 / V.AUX / DOCK : Select input source that is not used. <ul style="list-style-type: none"> • ON : Use this source. • Delete : Do not use this source. <div style="border: 1px solid black; padding: 5px; margin-top: 10px;"> <p>NOTE</p> <ul style="list-style-type: none"> • Input sources being used in the various zones cannot be deleted. • Input sources set to “Delete” cannot be selected using the input source select button. </div> 

Setting items	Setting details
<p>GUI Make the settings related to displays on the TV screen.</p>	<p>Screensaver : Make screensaver settings.</p> <ul style="list-style-type: none"> • ON : The screensaver is activated during menu display, iPod or TUNER screen display if no operation is performed for an approximately 5-minute continuous period. When you press $\Delta \nabla \triangleleft \triangleright$, the screensaver is cancelled and the screen before that screen saver started is displayed. • OFF : Screensaver is not activated.  <p>Format : Set the video signal format to be output for the TV you are using.</p> <ul style="list-style-type: none"> • NTSC : Select NTSC output. • PAL : Select PAL output. <p> "Format" can also be set by the following procedure. However, the menu screen is not displayed.</p> <ol style="list-style-type: none"> 1. Press and hold the main unit's \blacksquare and \blacktriangleright for at least 3 seconds. "V.Format:<NTSC>" appears on the display. 2. Press the main unit's TUNER PRESET CH +, - and set the video signal format. 3. Press the main unit's iPod \blacktriangleright to complete the setting. <p>NOTE</p> <p>When a format other than the video format of the connected TV is set, the picture will not be displayed properly.</p> <p>Text : Display the details of operation when switching surround mode, input mode, etc.</p> <ul style="list-style-type: none"> • ON : Turn display on. • OFF : Turn display off. <p>Master Volume : Display the master volume during adjustment.</p> <ul style="list-style-type: none"> • Bottom : Display at the bottom. • Top : Display at the top. • OFF : Turn display off. <p> When the master volume display is hard to see when superimposed on movie subtitles, set to "Top".</p> <p>iPod : Set the iPod screen display time when the input source is "DOCK".</p> <ul style="list-style-type: none"> • Always : Show display continuously. • 30s : Show display for 30 seconds after operation. • 10s : Show display for 10 seconds after operation. • OFF : Turn display off.

Setting items	Setting details
<p>GUI (Continued)</p>	<p>Tuner : Set the tuner screen display time when the input source is "Tuner".</p> <ul style="list-style-type: none"> • Always : Show display continuously. • 30s : Show display for 30 seconds after operation. • 10s : Show display for 10 seconds after operation. • OFF : Turn display off.
<p>Remote Setup Guide Search a preset code to register in the remote control unit.</p>	<p>See "Registering preset codes" (page 75).</p>
<p>Quick Sel.Name Change the "Quick Select" display title to one you prefer.</p>	<ul style="list-style-type: none"> • Up to 16 characters can be input. • For character input, see page 50.
<p>Zone Rename Change the display title of each zone to one you prefer.</p>	<ul style="list-style-type: none"> • Up to 10 characters can be input. • For character input, see page 50.
<p>Dimmer Adjust the display brightness of this unit.</p>	<p>Bright : Normal display brightness. Dim : Reduced display brightness. Dark : Very low display brightness. OFF : Turns the display off.</p> <p> Buttons on the main unit can be used for operations. Each time DIMMER is pressed, the setting is changed as shown below.</p> 
<p>Setup Lock Protect settings from inadvertent change.</p>	<p>ON : Turn protection on. OFF : Turn protection off.</p> <p> When canceling the setting, set "Setup Lock" to "OFF".</p> <p>NOTE</p> <p>When "Setup Lock" is set to "ON", the settings listed below can no longer be changed. Also, "Setup Lock!" is displayed if you attempt to operate related settings.</p> <ul style="list-style-type: none"> • Menu operations • Channel Level

Language

Default settings are underlined.

Set the language for display on the menu screen.

Setting details

English / Español



"Language" can also be set by the following procedure. However, the menu screen is not displayed.

1. Press and hold the main unit's **■** and **▶▶I** for at least 3 seconds.

"V.Format:<NTSC>" appears on the display.

2. Press the main unit's **STATUS** and set "Lang:<ENGLISH >".

3. Press the main unit's **TUNER PRESET CH +, -** and set the language.

4. Press the main unit's **iPod ▶** to complete the setting.



Perform settings related to input source playback.

- You do not have to change the settings to use the unit. Make settings when needed.

Menu operation

1 Press **ZONE SELECT** to switch the zone mode to **M** (MAIN ZONE).

The **M** indicator lights.

2 Press **AMP** to set the remote control unit to AMP-operation mode.

3 Press **MENU**.

The menu is displayed on the TV screen.

4 Use Δ / ∇ to select the menu to be set or operated.

5 Press **ENTER** or \triangleright to enter the setting.

- To return to the previous item, press **RETURN** \leftarrow .
- Exiting the Menu, press **MENU** while the menu is displayed. The menu display disappears.

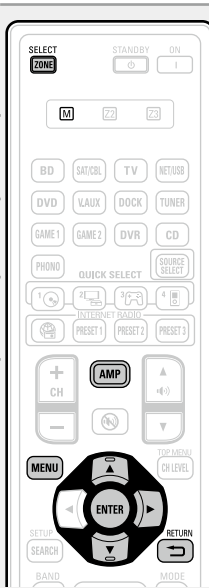

Items that can be set with the "Input Setup" procedure

Auto Preset ([page 69](#))

Preset Skip ([page 69](#))

Preset Name ([page 69](#))

Input Assign ([page 70](#))

Video ([page 71](#))

Input Mode (Audio) ([page 72](#))

Rename ([page 72](#))

Source Level (Audio) ([page 72](#))

Playback Mode ([page 73](#))

Important information

□ About the display of input sources

In this section, the configurable input sources for each item are shown as follows.

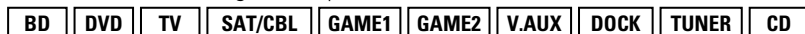

NOTE

Input sources that have been set to "Delete" at "Source Delete" ([page 65](#)) cannot be selected.

Auto Preset

Use the auto preset function to program radio stations.

Setting items	Setting details
Start Start the auto preset process. TUNER	 If an FM station cannot be preset automatically, select the desired station by tuning it in manually, then preset it manually.

Preset Skip

Default settings are underlined.

Set preset channel to be skipped when selecting.

Setting items	Setting details
Block Select the preset memory block. TUNER	<u>A / B / C / D / E / F / G</u>
Block Presets Skip all channels of the selected preset memory blocks. TUNER	<u>ON</u> : Display the selected preset memory block. <u>Skip</u> : Do not display the selected preset memory block.
A1 – G8 Set by individual preset channels in the currently selected preset memory block. TUNER	<u>ON</u> : Display the selected preset channel. <u>Skip</u> : Do not display the selected preset channel.  If you set “Block Presets” to “Skip”, you can skip by blocks (A – G).

Preset Name

Assign name to a preset memory.

Setting items	Setting details
Block Select the preset memory block. TUNER	<u>A / B / C / D / E / F / G</u>
A1 – G8 Change the display name of the selected channel. TUNER	<ul style="list-style-type: none"> • Up to eight characters can be input. • For character input, see page 50.
Default The changed preset name is returned to the default setting.	Yes : Reset to the defaults. No : Do not reset to the defaults.  When you select “Default” and press ENTER , the “Return settings to the default?” prompt is displayed. Select either “Yes” or “No”, and press ENTER .

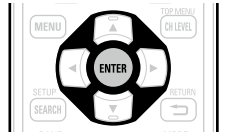

Input Assign

Examples of "Input Assign" menu screen displays

This screen appears when the "Input Setup" – "each input source" – "Input Assign" menu is selected. Use the "Input Assign" menu to change the ② HDMI input connectors, ③ Digital input connectors, and ④ component input connectors that are assigned to the ① input sources in default settings.

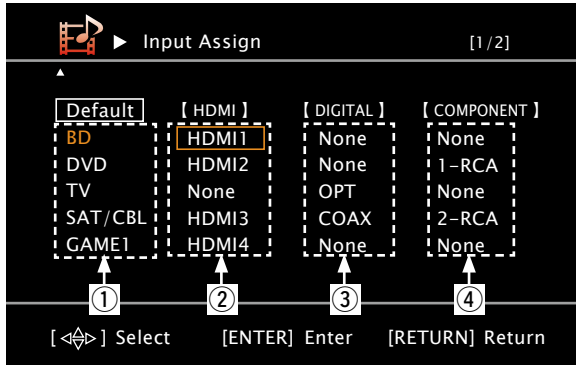



Input assignments menu operations

- 1** Use $\Delta \nabla \triangleleft \triangleright$ to move the highlight to the item you want to set.
- 2** Press **ENTER**, then use $\triangleleft \triangleright$ to select the input connector to be assigned.
- 3** Press **ENTER** to register the setting.



Setting items	Setting details																												
HDMI Set this to change the HDMI input connectors assigned to the input sources.	HDMI 1 / HDMI 2 / HDMI 3 / HDMI 4 / HDMI 5 / HDMI 6 None : Do not assign an HDMI input connector to the selected input source.																												
<table border="1"> <tr><td>BD</td><td>DVD</td><td>TV</td></tr> <tr><td>SAT/CBL</td><td>GAME1</td><td></td></tr> <tr><td>GAME2</td><td>V.AUX</td><td>DOCK</td></tr> </table>	BD	DVD	TV	SAT/CBL	GAME1		GAME2	V.AUX	DOCK	<ul style="list-style-type: none"> At time of purchase, the settings of the different input sources are as shown below. <table border="1"> <tr> <th>Input source</th> <th>BD</th> <th>DVD</th> <th>TV</th> <th>SAT/CBL</th> </tr> <tr> <td>Default setting</td> <td>HDMI 1</td> <td>HDMI 2</td> <td>None</td> <td>HDMI 3</td> </tr> </table>					Input source	BD	DVD	TV	SAT/CBL	Default setting	HDMI 1	HDMI 2	None	HDMI 3					
BD	DVD	TV																											
SAT/CBL	GAME1																												
GAME2	V.AUX	DOCK																											
Input source	BD	DVD	TV	SAT/CBL																									
Default setting	HDMI 1	HDMI 2	None	HDMI 3																									
	<table border="1"> <tr> <th>Input source</th> <th>GAME1</th> <th>GAME2</th> <th>V.AUX</th> <th>DOCK</th> </tr> <tr> <td>Default setting</td> <td>HDMI 4</td> <td>HDMI 5</td> <td>HDMI 6</td> <td>None</td> </tr> </table>					Input source	GAME1	GAME2	V.AUX	DOCK	Default setting	HDMI 4	HDMI 5	HDMI 6	None														
Input source	GAME1	GAME2	V.AUX	DOCK																									
Default setting	HDMI 4	HDMI 5	HDMI 6	None																									
	<ul style="list-style-type: none"> An input source to which an HDMI input connector cannot be assigned is displayed as "----". To play the video signal assigned at "HDMI" combined with the audio signal assigned at "Input Assign" – "DIGITAL", select "Digital" at "Input Mode" (page 72). The audio signals input from the analog and digital connectors are not output to the monitor. When a control dock for iPod is connected, signals cannot be assigned to the HDMI connectors. When "HDMI Control" (page 63) is set to "ON", HDMI input connector cannot be assigned to "TV". 																												
DIGITAL Set this to change the digital input connectors assigned to the input sources.	COAX (coaxial) / OPT (optical) None : Do not assign a digital input connector to the selected input source.																												
<table border="1"> <tr><td>BD</td><td>DVD</td><td>TV</td></tr> <tr><td>SAT/CBL</td><td>GAME1</td><td></td></tr> <tr><td>GAME2</td><td>V.AUX</td><td>DOCK</td></tr> <tr><td>CD</td><td></td><td></td></tr> </table>	BD	DVD	TV	SAT/CBL	GAME1		GAME2	V.AUX	DOCK	CD			<ul style="list-style-type: none"> At time of purchase, the settings of the different input sources are as shown below. <table border="1"> <tr> <th>Input source</th> <th>BD</th> <th>DVD</th> <th>TV</th> <th>SAT/CBL</th> <th>GAME1</th> </tr> <tr> <td>Default setting</td> <td>None</td> <td>None</td> <td>OPT</td> <td>COAX</td> <td>None</td> </tr> </table>					Input source	BD	DVD	TV	SAT/CBL	GAME1	Default setting	None	None	OPT	COAX	None
BD	DVD	TV																											
SAT/CBL	GAME1																												
GAME2	V.AUX	DOCK																											
CD																													
Input source	BD	DVD	TV	SAT/CBL	GAME1																								
Default setting	None	None	OPT	COAX	None																								
	<table border="1"> <tr> <th>Input source</th> <th>GAME2</th> <th>V.AUX</th> <th>DOCK</th> <th>CD</th> </tr> <tr> <td>Default setting</td> <td>None</td> <td>None</td> <td>None</td> <td>None</td> </tr> </table>					Input source	GAME2	V.AUX	DOCK	CD	Default setting	None	None	None	None														
Input source	GAME2	V.AUX	DOCK	CD																									
Default setting	None	None	None	None																									

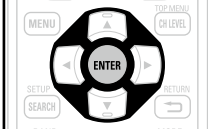

Setting items	Setting details																													
<p>COMPONENT (Component video) Set this to change the component video input connectors assigned to the input sources.</p> <table border="1"> <tr> <td>BD</td> <td>DVD</td> <td>TV</td> </tr> <tr> <td>SAT/CBL</td> <td>GAME1</td> <td></td> </tr> <tr> <td>GAME2</td> <td>V.AUX</td> <td>DOCK</td> </tr> </table>	BD	DVD	TV	SAT/CBL	GAME1		GAME2	V.AUX	DOCK	<p>COMP (Component video) 1, 2 None : Do not assign a component video input connector to the selected input source.</p> <ul style="list-style-type: none"> At time of purchase, the settings of the different input sources are as shown below. <table border="1"> <tr> <td>Input source</td> <td>BD</td> <td>DVD</td> <td>TV</td> <td>SAT/CBL</td> </tr> <tr> <td>Default setting</td> <td>None</td> <td>1-RCA</td> <td>None</td> <td>2-RCA</td> </tr> </table> <table border="1"> <tr> <td>Input source</td> <td>GAME1</td> <td>GAME2</td> <td>V.AUX</td> <td>DOCK</td> </tr> <tr> <td>Default setting</td> <td>None</td> <td>None</td> <td>None</td> <td>None</td> </tr> </table> <p></p> <ul style="list-style-type: none"> An input source to which an component video input connector cannot be assigned is displayed as “---”. When a control dock for iPod is connected, signals cannot be assigned to the component video connectors. 	Input source	BD	DVD	TV	SAT/CBL	Default setting	None	1-RCA	None	2-RCA	Input source	GAME1	GAME2	V.AUX	DOCK	Default setting	None	None	None	None
BD	DVD	TV																												
SAT/CBL	GAME1																													
GAME2	V.AUX	DOCK																												
Input source	BD	DVD	TV	SAT/CBL																										
Default setting	None	1-RCA	None	2-RCA																										
Input source	GAME1	GAME2	V.AUX	DOCK																										
Default setting	None	None	None	None																										
<p>Default The “Input Assign” settings are returned to the default settings.</p>	<p>Yes : Reset to the defaults. No : Do not reset to the defaults.</p> <p> If you select “Default” and press ENTER, the message “Return settings to the default?” is displayed. Select “Yes” or “No”, and then press ENTER.</p> 																													

Video

Default settings are underlined.

Set the source video.



* “BD”, “TV”, “GAME1” or “GAME2” can be set when “HDMI” ([page 70](#)) or “COMPONENT” ([page 71](#)) has been assigned.

Setting items	Setting details									
<p>Video Select Video of another input source is played back combined with the playing audio.</p>	<p>Source : Play the picture and sound of the input source. BD / DVD / TV / SAT/CBL / DOCK / GAME1 / GAME2 / V.AUX : Select video input source to view. This can be set for individual input sources.</p> <p> “BD”, “TV”, “GAME1” and “GAME2” can be selected only when a component video is assigned as an input source.</p> <p>NOTE</p> <ul style="list-style-type: none"> It is not possible to select HDMI input signals. Input sources for which “Delete” is selected at “Source Delete” (page 65) cannot be selected. 									
<p>Video Mode Make settings for video processing.</p> <table border="1"> <tr> <td>BD *</td> <td>DVD</td> <td>TV *</td> </tr> <tr> <td>SAT/CBL</td> <td>GAME1 *</td> <td></td> </tr> <tr> <td>GAME2 *</td> <td>V.AUX</td> <td>DOCK</td> </tr> </table>	BD *	DVD	TV *	SAT/CBL	GAME1 *		GAME2 *	V.AUX	DOCK	<p>Auto : Process video automatically based on the HDMI content information. Game : Always process video appropriate for game content. Movie : Process video normally.</p> <p></p> <ul style="list-style-type: none"> If “Video Mode” is set to “Auto”, the mode is switched according to the input contents. If a source is played in both MAIN ZONE (audio and video) and ZONE2 (audio only) modes in the same room, audio in MAIN ZONE and ZONE2 modes may sound out of synchronization, but this is not malfunction. In this case, setting to “Game” mode may improve audio synchronization.
BD *	DVD	TV *								
SAT/CBL	GAME1 *									
GAME2 *	V.AUX	DOCK								

Input Mode (Audio)

Default settings are underlined.

The input modes available for selection may vary depending on the input source.

Setting items	Setting details												
<p>Input Mode Set the audio input modes for the different input sources. It is normally recommended to set the audio input mode to "Auto".</p>	<p>Auto : Automatically detect input signal and perform playback. HDMI : Play only signals from HDMI input. Digital : Play only signals from digital input. Analog : Play only signals from analog input.</p> <p> <ul style="list-style-type: none"> "HDMI" can be set for input sources for which "HDMI" is assigned at "Input Assign" (page 70). "Digital" can be set for input sources for which "DIGITAL" is assigned at "Input Assign" (page 70). If the input source is set to "TV", "GAME1" or "GAME2", it cannot be set to "Analog". When digital signals are properly input, the DIG indicator lights on the display. If the DIG indicator does not light, check the digital input connector assignment and the connections. If "HDMI Control" is set to "ON" and a TV compatible with the ARC is connected via the HDMI MONITOR connectors, the input mode whose input source is "TV" is fixed to ARC. </p>												
<p>Decode Mode Set the audio decode mode for input source.</p> <table border="1" data-bbox="114 834 349 967"> <tr> <td>BD</td> <td>DVD</td> <td>TV</td> </tr> <tr> <td colspan="2">SAT/CBL</td> <td>GAME1</td> </tr> <tr> <td>GAME2</td> <td>V.AUX</td> <td>DOCK</td> </tr> <tr> <td>CD</td> <td colspan="2"></td> </tr> </table>	BD	DVD	TV	SAT/CBL		GAME1	GAME2	V.AUX	DOCK	CD			<p>Auto : Detect type of digital input signal and decode and play automatically. PCM : Decode and play only PCM input signals. DTS : Decode and play only DTS input signals.</p> <p> <ul style="list-style-type: none"> This item can be set for input sources for which "HDMI" or "DIGITAL" is assigned at "Input Assign" (page 70). Normally set this mode to "Auto". Set "PCM" and "DTS" when inputting the corresponding input signal. </p>
BD	DVD	TV											
SAT/CBL		GAME1											
GAME2	V.AUX	DOCK											
CD													

Rename

Change the display name of the selected input source.

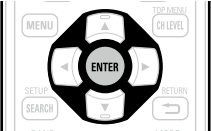
Setting items	Setting details
<p>Rename Change the display name of the selected input source.</p>	<ul style="list-style-type: none"> Up to eight characters can be input. For character input, see page 50.
<p>Default The input source name is returned to the default setting.</p>	<p>Yes : Reset to the defaults. No : Do not reset to the defaults.</p> <p> If you select "Default" and press ENTER, the message "Return settings to the default?" is displayed. Select "Yes" or "No", and then press ENTER.</p> 

Source Level (Audio)

Default settings are underlined.

- This function corrects the playback level of the selected input source's audio input.
- Make this setting if there are differences in the input volume levels between the different sources.

Setting details

-12dB - +12dB (0dB)

-  The analog input level and digital input level can be adjusted independently for input sources for which "HDMI" or "DIGITAL" is assigned at "Input Assign" ([page 70](#)).

Playback Mode

Default settings are underlined.

Input source : "DOCK"

Setting items	Setting details
Repeat Make settings for repeat mode. <input type="checkbox"/> DOCK	All : All files are played repeatedly. One : A file being played is played repeatedly. OFF : Repeat playback mode is canceled.
Shuffle Make settings for shuffle mode. <input type="checkbox"/> DOCK	<input type="checkbox"/> When DENON control dock for iPod ASD-1R or ASD-11R is connected Songs : All files are played in shuffle playback mode. Albums : Files in the album are played in shuffle playback mode. OFF : Shuffle playback mode is canceled. <input type="checkbox"/> When DENON control dock for iPod ASD-3N, ASD-3W, ASD-51N or ASD-51W is connected ON : Shuffle playback mode is enabled. OFF : Shuffle playback mode is canceled.

Operating the connected devices by remote control unit

Registering the supplied preset codes in the remote control unit enables you to operate devices made by other manufacturers.

Operating AV devices

1 Press **ZONE SELECT** to select a zone for operation.

The zone mode indicator corresponding to the operating zone lights.

- The mode switches each time **ZONE SELECT** is pressed.

M Select for the operations in MAIN ZONE.

Z2 Select for the operations in ZONE2.

Z3 Not used.

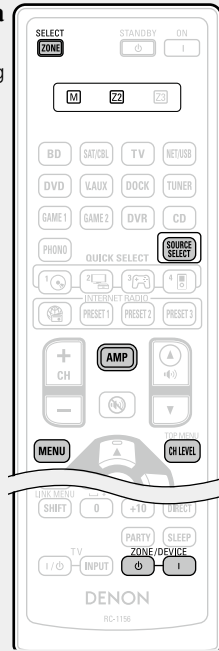

2 Press the input source select button (page 20).

- The input source for the zone selected in step 1 is switched.
- The operation mode of the remote control unit is switched as shown in the table.

Input source select button	Input source of this unit	Operation mode
		Devices controllable with the remote control unit
AMP	–	This unit (AMP-operation) *2
BD *1	BD	Device registered on the BD button
SAT/CBL *1	SAT/CBL	Device registered on the SAT/CBL button
TV *1	TV	Device registered on the TV button
DVD *1	DVD	Device registered on the DVD button
V.AUX *1	V.AUX	Device registered on the V.AUX button
DOCK	DOCK	Control dock for iPod
TUNER	TUNER	Radio of this unit
GAME1 *1	GAME1	Device registered on the GAME1 button
GAME2 *1	GAME2	Device registered on the GAME2 button
CD *1	CD	Device registered on the CD button

*1 If a preset code is registered for this button, the remote control unit of this unit can control another devices.

*2 This operation mode enables you to operate iPod, Control dock for iPod and TUNER.



When the **SOURCE SELECT** is pressed, the AMP-operation mode starts automatically.

NOTE

If the mode of the remote control unit is set to other than AMP-operation mode, press **AMP** to switch the remote control unit to the AMP-operation mode to perform the following operations:

- For menu operation by pressing **MENU**
- For setting the channel level of the unit by pressing **CH LEVEL**
- For turning power in each zone on or off by pressing **ZONE/DEVICE I** or **ZONE/DEVICE 0**.

3 Operate this unit or the device whose input source is switched.

- For details, refer to the operating instructions for each device. For operations of iPod and TUNER, see the following pages.

- iPod (page 23)
- TUNER (page 26)

Registering preset codes

When preset codes are registered in the included remote control unit, it can then be used to operate any devices you have, such as DVD players or TVs made by different manufacturers. In this menu, you can search and display the preset codes that can be preset in the included remote control unit.

Buttons used for operating the devices

- ① **ZONE/DEVICE 1, ZONE/DEVICE 2**
For switching power of each device on or off.
- ② **△▽◀▶, ENTER, RETURN**
For menu operation of each device.
- ③ **MENU, SETUP, TOP MENU**
For displaying the menu of each device.
- ④ **◀◀, ▶▶, ▶, ◀, ◀◀, ▶▶▶, II, ■**
- ⑤ Number button (0 – 9, +10)
- ⑥ **CH +, CH –**
- ⑦ **TV I/⏻, TV INPUT**
For operating a TV
This button is enabled in any mode.

For details on operation with the remote control unit, see pages 23, 26, 77.

Default settings for preset codes

The devices shown below are registered for each input source button as default. Settings can be changed according to the devices to be used.

Input source select button	Category	Brand	Preset code
BD	Blu-ray Disc player	DENON	32258
SAT/CBL	Satellite set top box	DirecTV	01377
TV	Television	SONY	10810
DVD	DVD player	DENON	32134
V.AUX	Digital camcorder (DVD recorder)	Panasonic	21378
DOCK*	Control dock for iPod	DENON	72516
GAME1	Cable set top box	Motorola	01376
GAME2	Cable set top box	Scientific Atlanta	01877
CD	CD player	DENON	42867

* If a control dock for iPod is not to be used, the preset code for another device can be set to **DOCK**.

NOTE

The preset code cannot be registered to **NET/USB, TUNER** or **PHONO**.

1 Press **ZONE SELECT** to switch the zone mode to **M** (MAIN ZONE).
The **M** indicator lights.

2 Press **AMP** to set the remote control unit to AMP-operation mode.

3 Press **MENU**.
The menu is displayed on the TV screen.

4 Use **△▽** to select “System Setup” – “Option Setup” – “Remote Setup Guide” and then press **ENTER** or **▶**.

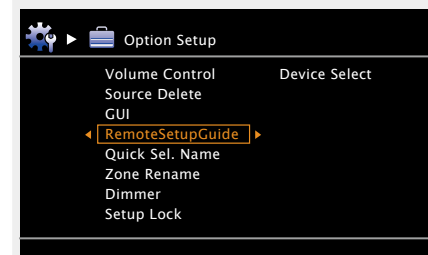

5 Pressing **△▽**, select the device category for preset registration. Then press **ENTER**.

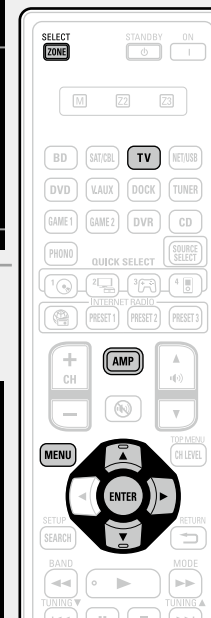
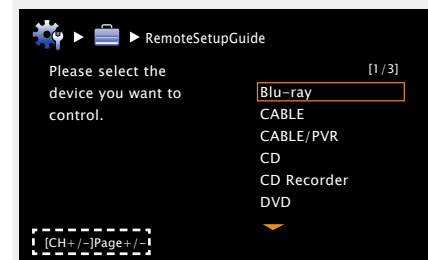

- For “TV”, “TV/DVD” or “TV/VCR” categories, only the preset code for **TV** can be registered.
- The pages can be switched by pressing the remote control unit’s **CH +** or **CH –**.

6 Pressing Δ / ∇ , select the first letter of the device brand name. Then press ENTER.

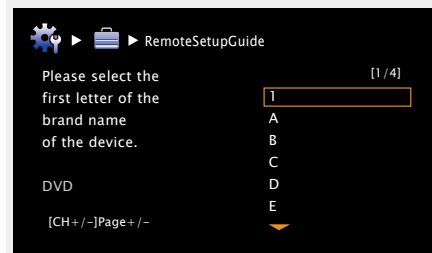

- The first character is displayed as 1, A to Z. (Initials for the brand are displayed for each category.)
For brand names that start with numbers and symbols, select "1".
- When there are several pages of brand names, the pages can be switched by pressing the remote control unit's **CH +** or **CH -**.

7 Pressing Δ / ∇ , select the device brand name. Then press ENTER.

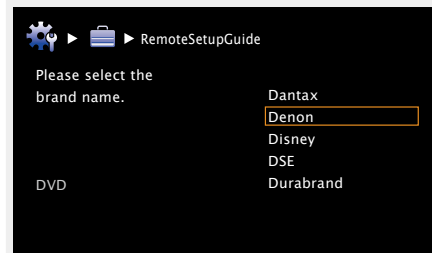

- When there are several pages of brand names, the pages can be switched by pressing the remote control unit's **CH +** or **CH -**.

NOTE

If the desired brand name is not listed, the supplied remote control unit cannot control the device. Use the remote control unit supplied with the device to be used.

8 The procedures for registering remote control codes and remote control preset registration are displayed.

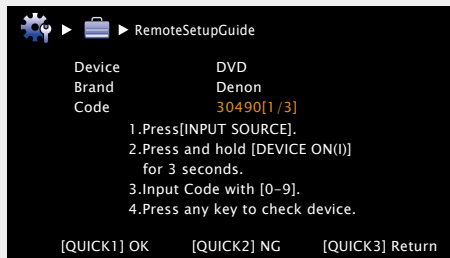

NOTE

If a wrong brand name is selected, press **QUICK SELECT 3**. The following screen is displayed:

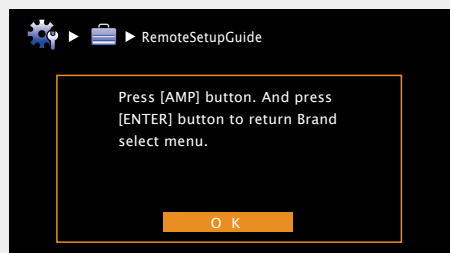

Press **AMP** then **ENTER** to return to step 7.

9 Press the input source button on which the preset code is to be registered (BD, SAT/CBL, TV, DVD, V.AUX, DOCK, GAME1, GAME2 or CD).

- For **TV**, only the preset code for the categories "TV", "TV/DVD", or "TV/VCR" can be registered.

10 Press and hold ZONE/DEVICE I for at least 3 seconds. The zone mode indicator flashes twice.

11 Enter a five-digit code using 0 - 9. Press the buttons with an interval less than 10 seconds.

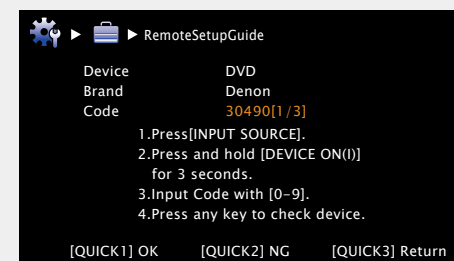

- When the code is registered.
→ The zone mode indicator flashes twice.
- When the code is not registered correctly
→ The mode indicator slowly flashes once. Perform from step 9 again.
- When an input number is not correct
→ Press **ON** once then perform the operations from step 9 again.

12 Operate the device being used to check the operation.

- If the device is operating, press **QUICK SELECT 1**.
→ Go to step 13.
- If the device is not operating, press **QUICK SELECT 2**.
→ Go to step 14.

13 The screen shown below is displayed, and registration of the preset code is completed.

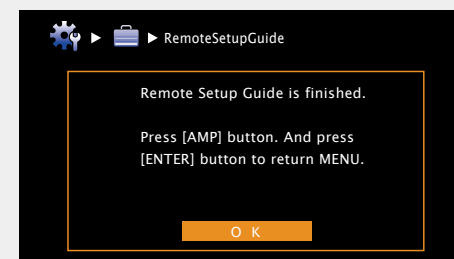

- The menu screen is retrieved. Press **AMP** then **ENTER**.

14 Either of the screens below is displayed.

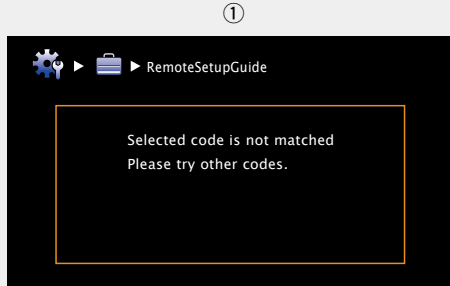

- The screen is displayed for 3 seconds, then the next preset registration screen is displayed automatically.

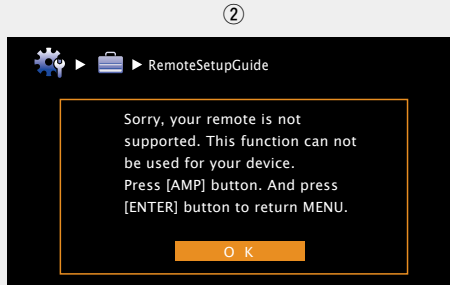

【If screen ① is displayed】

The device may be operating with the preset code displayed next. The preset registration screen is displayed. Repeat steps 9 to 12.

【If screen ② is displayed】

The device cannot be controlled with the remote control unit supplied with this unit. Use the remote control unit supplied with the device to be used. The menu screen is retrieved. Press **AMP** then **ENTER**.



Some manufacturers use more than one type of remote control code. Preset codes to change the number and verify correct operation.

NOTE

Depending on the model and year of manufacture of your device, some buttons may not operate.

Operating devices

The supplied remote control unit can control a device other than this unit.

1 Press the input source select button to which the preset code for the device you want to operate has been registered (see [page 74](#)).

2 Operate the device.

- For details, refer to the device's operating instructions.

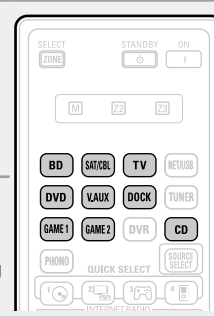

Blu-ray Disc player / HD-DVD player / DVD player operation

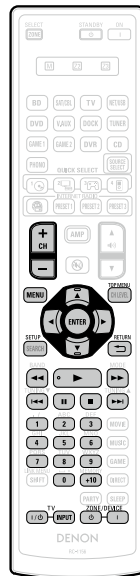

Operation buttons	Function
CH +, -	Switch channels (up/down)
MENU	(Popup) Menu
TOP MENU	Top menu
△▽◀▶	Cursor operation
ENTER	Enter
SETUP	Setup
RETURN ↶	Return
◀▶▶▶	Manual search (fast-reverse/fast-forward)
▶	Playback
◀▶▶▶	Auto search (cue)
 	Pause
■	Stop
0-9, +10	Select title, chapter or channel selection
TV I / ⏻	TV power on/standby (Default : SONY)
TV INPUT	Switch TV input (Default : SONY)
ZONE/DEVICE I	Power on*
ZONE/DEVICE ⏻	Power standby*

* This may power some devices on/standby.

CD player / CD recorder operation



Operation buttons	Function
△▽◀▶	Cursor operation
ENTER	Enter
◀▶▶▶	Manual search (fast-reverse/fast-forward)
▶	Playback
◀▶▶▶	Auto search (cue)
 	Pause
■	Stop
0-9, +10	Track selection
TV I / ⏻	TV power on/standby (Default : SONY)
TV INPUT	Switch TV input (Default : SONY)
ZONE/DEVICE I	Power on*
ZONE/DEVICE ⏻	Power standby*

* This may power some devices on/standby.

❑ DVD recorder / Personal video recorder (PVR) / Video cassette recorder (VCR) operation



Operation buttons	Function
CH +, -	Switch channels (up/down)
MENU	Menu
$\Delta \nabla \triangleleft \triangleright$	Cursor operation
ENTER	Enter
SETUP	Setup
RETURN ↶	Return
$\ll \gg$	Manual search (fast-reverse/fast-forward)
\triangleright	Playback
$\ll \ll \ll \triangleright \triangleright \triangleright$	Auto search (cue)
II	Pause
\blacksquare	Stop
0 - 9, +10	Select title, chapter or channel selection
TV I / ⏻	TV power on/standby (Default : SONY)
TV INPUT	Switch TV input (Default : SONY)
ZONE/DEVICE I	Power on*
ZONE/DEVICE ⏻	Power standby*

* This may power some devices on/standby.

❑ TV operation

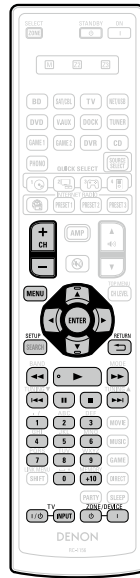

Operation buttons	Function
CH +, -	Switch channels (up/down)
MENU	Menu
$\Delta \nabla \triangleleft \triangleright$	Cursor operation
ENTER	Enter
SETUP	Setup
RETURN ↶	Return
$\ll \gg$	Manual search (fast-reverse/fast-forward)
\triangleright	Playback
$\ll \ll \ll \triangleright \triangleright \triangleright$	Auto search (cue)
II	Pause
\blacksquare	Stop
0 - 9, +10	Channel selection
TV I / ⏻	TV power on/standby (Default : SONY)
TV INPUT	Switch TV input (Default : SONY)
ZONE/DEVICE I	Power on*
ZONE/DEVICE ⏻	Power standby*

* This may power some devices on/standby.

❑ Set top box for satellite (SAT) / Cable (CBL) / IP TV operation



Operation buttons	Function
CH +, -	Switch channels (up/down)
MENU	Menu
$\Delta \nabla \triangleleft \triangleright$	Cursor operation
ENTER	Enter
SETUP	Guide
RETURN ↶	Return
$\ll \gg$	Manual search (fast-reverse/fast-forward)
\triangleright	Playback
$\ll \ll \ll \triangleright \triangleright \triangleright$	Auto search (cue)
II	Pause
\blacksquare	Stop
0 - 9, +10	Channel selection
TV I / ⏻	TV power on/standby (Default : SONY)
TV INPUT	Switch TV input (Default : SONY)
ZONE/DEVICE I	Power on*
ZONE/DEVICE ⏻	Power standby*

* This may power some devices on/standby.

Specifying the zone used with the main remote control unit

When the **ZONE SELECT** button is pressed, only the set zone can be operated with the remote control unit.

1 Press and hold **ZONE/DEVICE 1** for at least 3 seconds.

The zone mode indicator flashes twice.

2 Press **ZONE SELECT**.

The zone mode indicator flashes twice.

3 Press **1 – 3** to set.

The zone mode indicator flashes twice.

[Settable items]

- 1 When only using "MAIN ZONE"
- 2 When using "MAIN ZONE" / "ZONE2"
- 3 When using "MAIN ZONE" / "ZONE2" / "ZONE3" (Default)

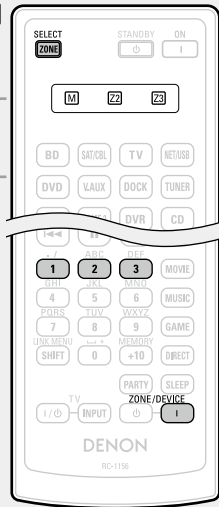

Resetting the remote control unit

Settings for the remote control unit are returned to the default values.

1 Press and hold **ZONE/DEVICE 1** for at least 3 seconds.

The zone mode indicator flashes twice.

2 Press **9, 8 and 1**, in that order.



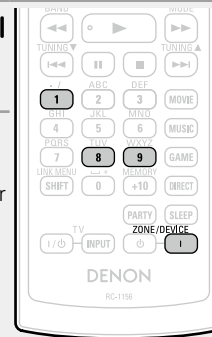

The [M] indicator flashes four times.

All the settings are restored to their defaults.



Information

Here, we list various information related to this unit.
Please refer to this information as needed.

- Part names and functions  [page 81](#)
- Other information  [page 86](#)
- Troubleshooting  [page 94](#)
- Specifications  [page 97](#)
- Index  [page 98](#)

Part names and functions

Front panel

For buttons not explained here, see the page indicated in parentheses ().

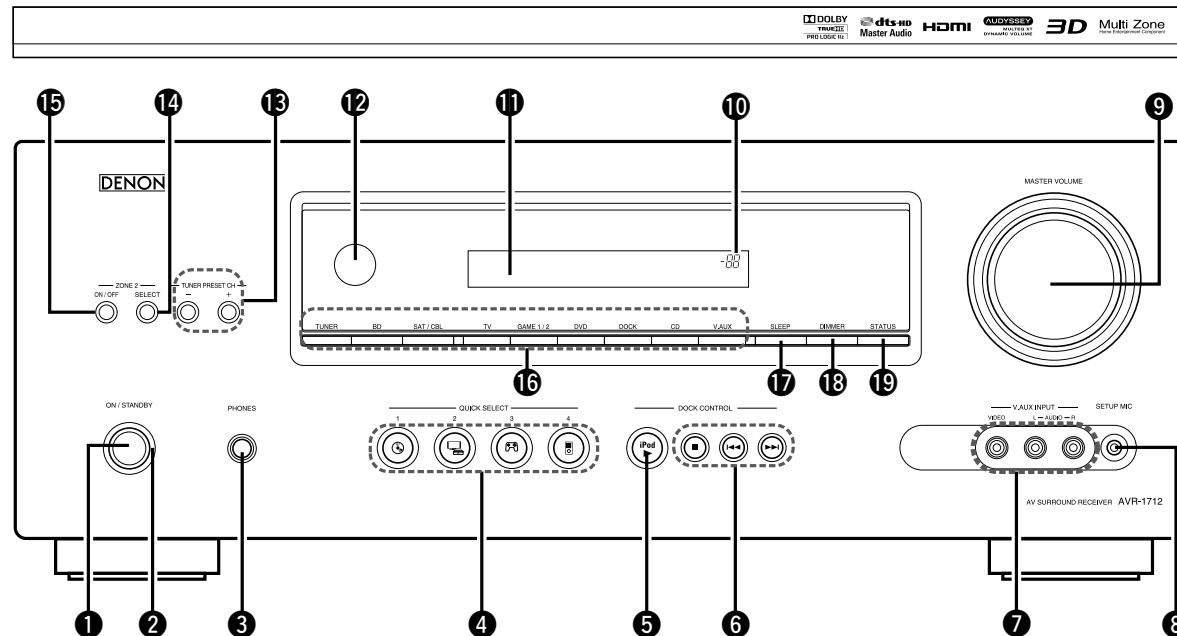

- 1 Power operation button (ON/STANDBY)** (5)
Turns power to this unit on and off (standby).
- 2 Power indicator** (5)
- 3 Headphones jack (PHONES)**
When the headphones are plugged into this jack, audio will no longer be output from the connected speakers.
NOTE
To prevent hearing loss, do not raise the volume level excessively when using headphones.
- 4 QUICK SELECT buttons** (44, 46)
- 5 iPod play button (iPod ►)** (24)

- 6 iPod system buttons** (23, 96)
 - Stop button (■)
 - Skip buttons (◀◀, ▶▶)
 - 7 V.AUX INPUT connectors** (10)
Remove the cap covering the connectors when you want to use them.
-
- 8 SETUP MIC jack** (15, 39)
 - 9 MASTER VOLUME control knob** (21)

- 10 Master volume indicator**
- 11 Display** (82)
- 12 Remote control sensor** (85)
- 13 Tuner preset channel buttons (TUNER PRESET CH +, -)** (26)
- 14 ZONE2 SELECT button** (45)
- 15 ZONE2 ON/OFF button** (45)
- 16 Input source select buttons** (20)
- 17 SLEEP button** (42, 46)
- 18 DIMMER button** (66)
- 19 STATUS button** (58)

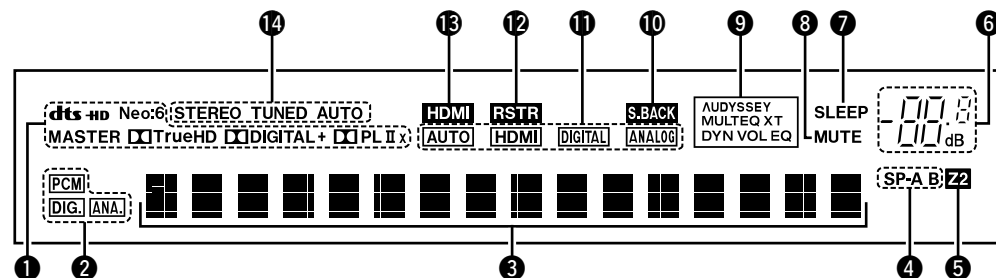

1 Decoder indicators

These light when the respective decoders are operating.

2 Input signal indicators

3 Information display

The input source name, surround mode, setting values and other information are displayed here.

4 Front speaker indicator

This lights according to the setting of the front A and B speakers.

5 Multi-zone indicators

This lights up when ZONE2 (separate room) power is turned on ([page 45](#)).

6 Master volume indicator

7 Sleep timer indicator

This lights when the sleep mode is selected ([page 42, 46](#)).

8 MUTE indicator

This lights when the mute mode is selected ([page 21](#)).

9 Audyssey® indicators

Light up as follows, depending on the setting of "MultEQ® XT", "Dynamic EQ®" ([page 55](#)), "Dynamic EQ®" ([page 56](#)) and "Dynamic Volume®" ([page 56](#)).

AUDYSSEY MULTEQ XT DYN VOL	When "MultEQ® XT", "Dynamic EQ®" and "Dynamic Volume®" are "ON".
----------------------------------	--

AUDYSSEY MULTEQ XT DYN EQ	When "MultEQ® XT" and "Dynamic EQ®" are "ON" and "Dynamic Volume®" is "OFF".
---------------------------------	--

AUDYSSEY MULTEQ XT	When "MultEQ® XT" is "ON" and "Dynamic EQ®" and "Dynamic Volume®" are "OFF".
-----------------------	--

10 Surround back indicator

This lights when audio signals are being output from the surround back speakers ([page 60](#)).

11 Input mode indicators

Set the audio input modes for the different input sources ([page 72](#)).

12 RESTORER indicator

This lights when the RESTORER mode is selected ([page 57](#)).

13 HDMI indicator

This lights when playing using HDMI connections.

14 Tuner reception mode indicators

These light according to the reception conditions when the input source is set to "TUNER".

STEREO : In the FM mode, this lights up when receiving stereo broadcasts.

TUNED : Lights up when the broadcast is properly tuned in.

AUTO : Lights up when in the auto tuning mode.

Rear panel

See the page indicated in parentheses ().

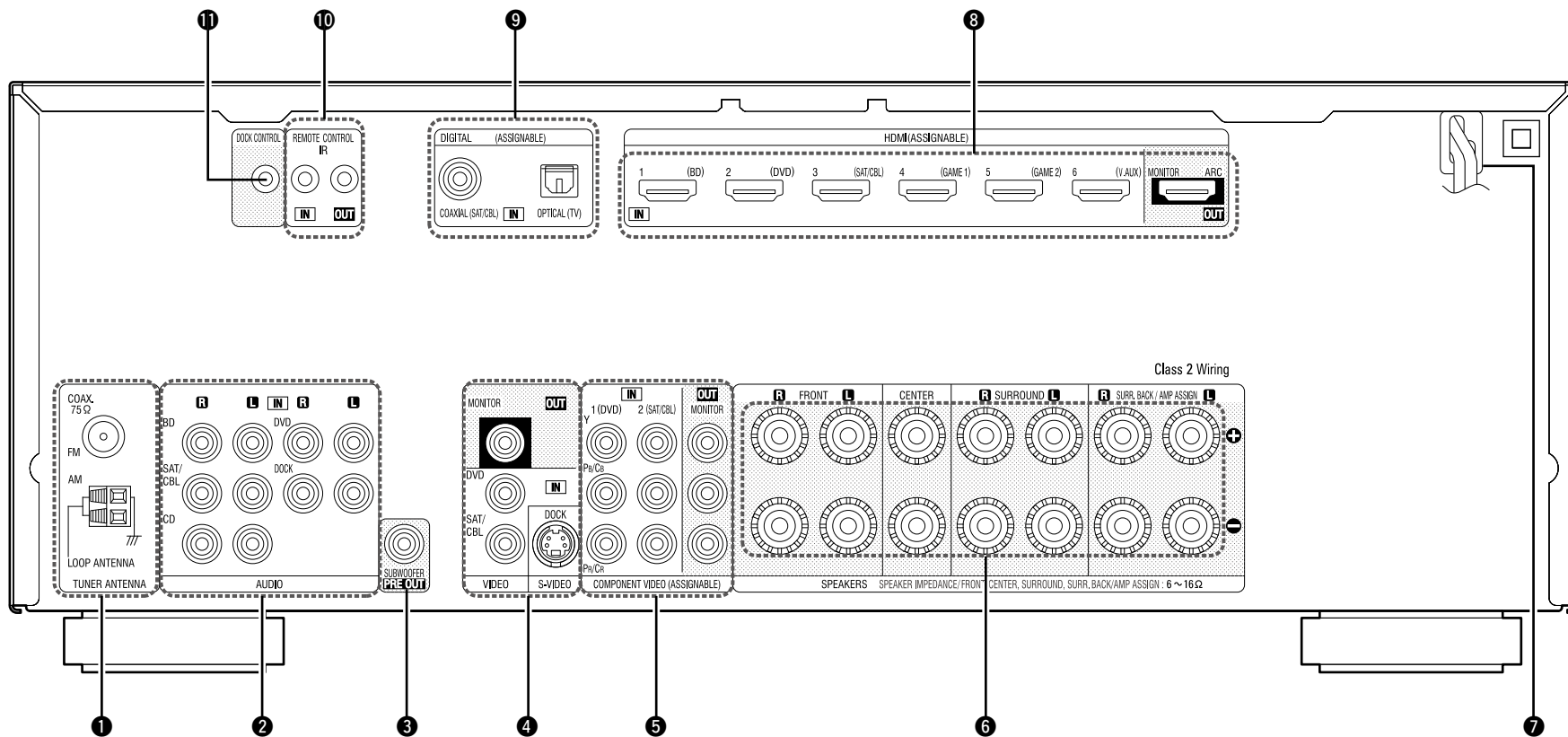

- ❶ FM/AM antenna terminals (11)
- ❷ Analog audio connectors (9, 10, 11)
- ❸ PRE OUT connectors (6, 34, 35, 36, 37, 38)
- ❹ S-VIDEO/VIDEO connectors (8, 9, 10)
- ❺ COMPONENT VIDEO connectors (8, 9)
- ❻ Speaker terminals (6, 34, 35, 36, 37, 38)
- ❼ Power cord (5)
- ❽ HDMI connectors (3, 7)
- ❹ Digital audio connectors (8, 9)
- ❷ REMOTE CONTROL jacks (12)
- ❶ DOCK CONTROL jack (10)

NOTE

Do not touch the inner pins of the connectors on the rear panel. Electrostatic discharge may cause permanent damage to the unit.

Remote control unit

For buttons not explained here, see the page indicated in parentheses ().

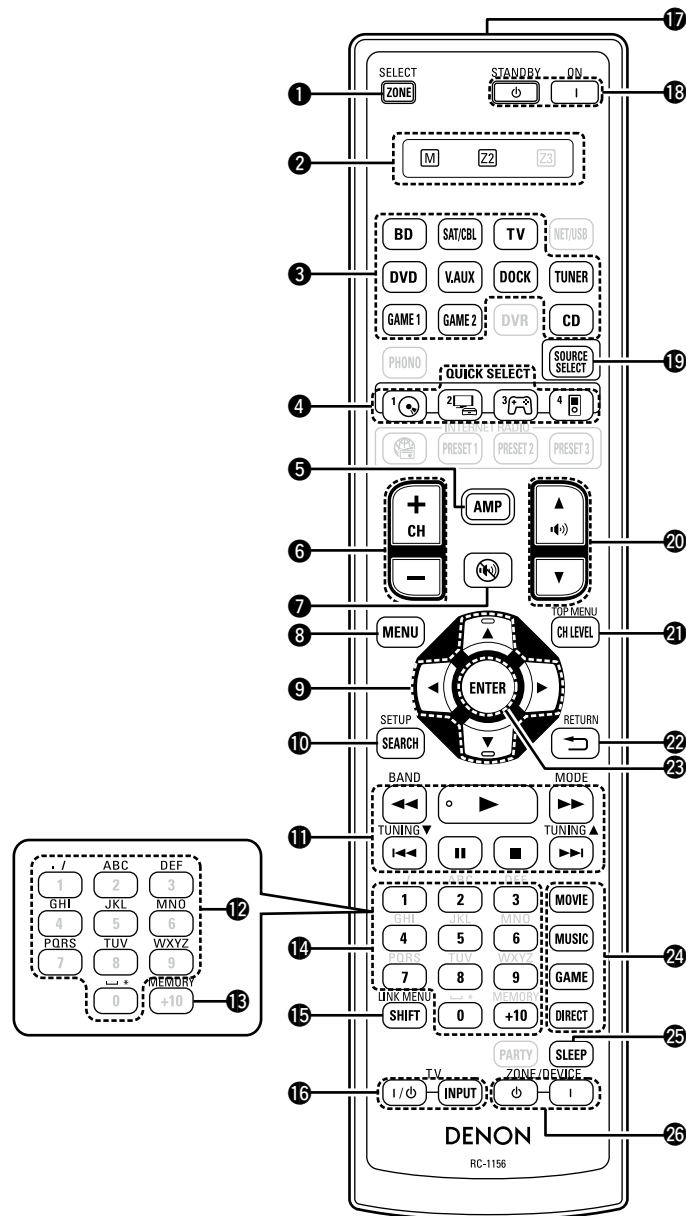

- 1 ZONE SELECT button (45, 74)
- 2 Zone mode indicators (74)
- 3 Input source select buttons (20, 45)
- 4 QUICK SELECT buttons (44, 46)
- 5 AMP button (74)
- 6 Channel buttons
(CH +, -) (25, 26, 75, 77, 78)
- 7 Muting button (M) (21, 45)
- 8 MENU button (52)
- 9 Cursor buttons
(Δ ∇ \triangleleft \triangleright) (49, 50, 51, 52)
- 10 SEARCH button (22, 26, 51)
- 11 System buttons (23, 77, 78)
 - Search buttons (\triangleleft , \triangleright)
 - Skip buttons (\mathbb{I} , \mathbb{II})
 - Play button (\blacktriangleright)
 - Pause button (\mathbb{II})
 - Stop button (\blacksquare)
- Tuner system buttons (26)
 - FM/AM band switching button (BAND)
 - Tuning mode button (MODE)
 - Tuning up / Tuning down buttons
(TUNING Δ ∇)
- 12 Character buttons (51)
- 13 MEMORY buttons (25)
- 14 Number buttons
..... (25, 75, 76, 77, 78)
- 15 SHIFT button (25, 51)
- 16 TV operation buttons
(TV | / ϕ / INPUT) (77, 78)
- 17 Remote control signal transmitter (85)
- 18 Power buttons
(ON / STANDBY) (5)
- 19 SOURCE SELECT button (20)
- 20 Master volume control buttons
(\mathbb{I} \mathbb{II}) Δ ∇ (21, 45)
- 21 Channel level button (CH LEVEL) (43)
- 22 RETURN button (\curvearrowright) (52)
- 23 ENTER button (49, 50, 51, 52)
- 24 Surround mode buttons (27)
 - MOVIE button
 - MUSIC button
 - GAME button
 - DIRECT button
- 25 SLEEP button (42, 46)
- 26 ZONE/DEVICE power buttons
..... (45, 77, 78)

NOTE

The NET/USB, DVR, PHONO, INTERNET RADIO (\mathbb{R}), PRESET 1, PRESET 2, PRESET 3 and PARTY buttons cannot be used.

Inserting the batteries

- ① Slide the rear lid in the direction of the arrow and remove it.

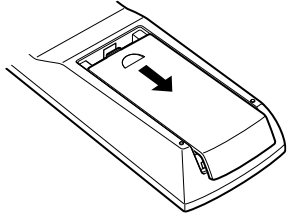

- ② Load the two batteries properly as indicated by the marks in the battery compartment.

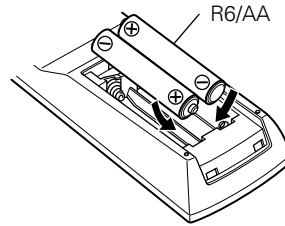

- ③ Put the rear cover back on.

NOTE

- Insert the specified batteries in the remote control unit.
- Replace the batteries with new ones if the set does not operate even when the remote control unit is operated close to the unit. (The supplied batteries are only for verifying operation.)
- When inserting the batteries, be sure to do so in the proper direction, following the ⊕ and ⊖ marks in the battery compartment.
- To prevent damage or leakage of battery fluid:
 - Do not use a new battery together with an old one.
 - Do not use two different types of batteries.
 - Do not attempt to charge dry batteries.
 - Do not short-circuit, disassemble, heat or dispose of batteries in flames.
 - Do not keep the battery in a place exposed to direct sunlight or in places with extremely high temperatures, such as near a heater.
- If the battery fluid should leak, carefully wipe the fluid off the inside of the battery compartment and insert new batteries.
- Remove the batteries from the remote control unit if it will not be in use for long periods.
- Used batteries should be disposed of in accordance with the local regulations regarding battery disposal.
- The remote control unit may function improperly if rechargeable batteries are used.

Operating range of the remote control unit

Point the remote control unit at the remote sensor when operating it.

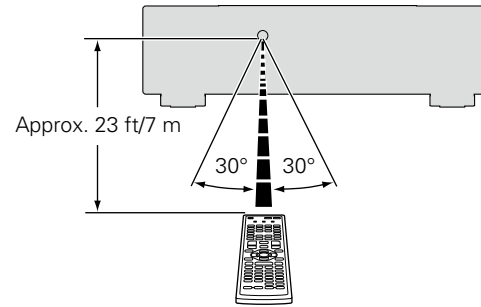

NOTE

- The set may function improperly or the remote control unit may not operate if the remote control sensor is exposed to direct sunlight, strong artificial light from an inverter type fluorescent lamp or infrared light.
- When using 3D video devices that transmit radio communication signals (such as infrared signals etc) between the various units (such as the monitor, 3D glasses, 3D transmitter unit etc), the remote control unit may not operate due to interference from those radio communication signals. If this occurs, adjust the direction and distance of the 3D communication for each unit, and check that the remote control unit operation is not affected by these signals.

Other information

- ❑ **Trademark information** ([page 86](#))
- ❑ **Surround** ([page 87](#))
- ❑ **Relationship between video signals and monitor output** ([page 91](#))
- ❑ **Explanation of terms** ([page 92](#))

Trademark information

This product uses the following technologies:



Manufactured under license from Dolby Laboratories. "Dolby", "Pro Logic" and the double-D symbol are trademarks of Dolby Laboratories.



Manufactured under license under U.S. Patent #'s: 5,451,942; 5,956,674; 5,974,380; 5,978,762; 6,226,616; 6,487,535; 7,212,872; 7,333,929; 7,392,195; 7,272,567 & other U.S. and worldwide patents issued & pending. DTS and the Symbol are registered trademarks, & DTS-HD, DTS-HD Master Audio, and the DTS logos are trademarks of DTS, Inc. Product includes software. © DTS, Inc. All Rights Reserved.



HDMI, the HDMI Logo and High-Definition Multimedia Interface are trademarks or registered trademarks of HDMI Licensing LLC in the United States and other countries.



Manufactured under license from Audyssey Laboratories™. U.S. and foreign patents pending. Audyssey MultEQ® XT is a registered trademark of Audyssey Laboratories. Audyssey Dynamic EQ® is a registered trademark of Audyssey Laboratories. Audyssey Dynamic Volume® is a registered trademark of Audyssey Laboratories.

Surround

This unit is equipped with a digital signal processing circuit that lets you play program sources in the surround mode to achieve the same sense of presence as in a movie theater.

Surround modes and surround parameters

This table shows the speakers that can be used in each surround mode and the surround parameters adjustable in each surround mode.

Symbols in the table

- This indicates the audio output channels or surround parameters that can be set.
- ◎ This indicates the audio output channels. The output channels depend on the settings of "Speaker Config." (page 60).

Surround mode (page 27)	Channel output						Surr.Parameter (page 53)							
	Front L/R	Center	Surround L/R	Surround Back L/R	Front Height L/R	Subwoofer	Mode (page 53)	Cinema EQ. (page 53)	DRC *9 (page 53)	D. Comp *10 (page 53)	LFE *11 (page 53)	Delay Time (page 53)	Effect Level (page 53)	Room Size (page 53)
DIRECT/PURE DIRECT (2channel)*1	○					◎*4			○	○				
DIRECT/PURE DIRECT (Multi-channel)*1	○	◎	◎	◎*2	◎*2	◎			○	○	○			
STEREO	○					◎			○	○	○			
MULTI CH IN	○	◎	◎	◎	◎*3	◎		◎*6			○			
DOLBY PRO LOGIC IIz	○	◎	◎		◎	◎	○*5	○	○					
DOLBY PRO LOGIC IIx	○	◎	◎	◎		◎	○	◎*8	○	○				
DOLBY PRO LOGIC II	○	◎	◎			◎	○	◎*7	○	○				
DTS NEO:6	○	◎	◎	◎		◎	○	◎*8	○	○				
DOLBY DIGITAL	○	◎	◎	◎	◎*3	◎		◎*6		○	○			
DOLBY DIGITAL Plus	○	◎	◎	◎	◎*3	◎		◎*6		○	○			
DOLBY TrueHD	○	◎	◎	◎	◎*3	◎		◎*6	○		○			
DTS SURROUND	○	◎	◎	◎	◎*3	◎		◎*6		○	○			
DTS 96/24	○	◎	◎	◎	◎*3	◎		◎*6		○	○			
DTS-HD	○	◎	◎	◎	◎*3	◎		◎*6		○	○			
DTS Express	○	◎	◎	◎	◎*3	◎		◎*6		○	○			
MULTI CH STEREO	○	◎	◎	◎	◎	◎			○	○	○			
ROCK ARENA	○	◎	◎	◎	◎	◎			○	○	○		○	○
JAZZ CLUB	○	◎	◎	◎	◎	◎			○	○	○		○	○
MONO MOVIE	○	◎	◎	◎	◎	◎			○	○	○		○	○
VIDEO GAME	○	◎	◎	◎	◎	◎			○	○	○		○	○
MATRIX	○	◎	◎	◎	◎	◎			○	○	○	○		
VIRTUAL	○					◎			○	○	○	○		

- *1 During playback in PURE DIRECT mode, the surround parameters are the same as in DIRECT mode.
- *2 A signal for each channel contained in an input signal is output as audio.
- *3 If "Surr.Parameter" – "PLIIz Height" (page 54) is set to "ON", sound is output from the front height speakers.
- *4 Only when "Subwoofer Mode" is set to "LFE+Main" (page 61), sound is output from the subwoofer.
- *5 If this surround mode is selected, only the "Height" mode setting is available for "Surr.Parameter" – "Mode" (page 53).
- *6 This item cannot be set when "Surr.Parameter" – "S.Back" (page 54) is set to "PLIIx Music".
- *7 This item can be selected when "Surr.Parameter" – "Mode" (page 53) is set to "Cinema" or "Pro Logic".
- *8 This item can be selected when "Surr.Parameter" – "Mode" (page 53) is set to "Cinema".
- *9 This item can be selected when a Dolby TrueHD signal is played.
- *10 This item can be selected when a Dolby Digital or DTS signal is played.
- *11 This item can be selected when a Dolby Digital or DTS signal or DVD-Audio is played.

Surround mode (page 27)	Surr.Parameter (page 53)								Tone * 15 (page 55)	Audyssey Settings* 17 (page 55)			RESTORER *20 (page 57)	
	Height Gain (page 54)	PLIIz Height * 13 (page 54)	AFDM * 14 (page 54)	S.Back (page 54)	Subwoofer (page 54)	PRO LOGIC II/IIx Music mode only				NEO:6 Music mode only	MultEQ® XT (page 55)	Dynamic EQ® * 18 (page 56)		Dynamic Volume® * 19 (page 56)
						Panorama (page 53)	Dimension (page 53)	C.Width (page 53)						
DIRECT/PURE DIRECT (2 channel)* 1					○*4									
DIRECT/PURE DIRECT (Multi-channel)* 1														
STEREO									○	○	○	○		
MULTI CH IN	○*12	○							○	○	○	○		
DOLBY PRO LOGIC IIz	○	○							○	○	○	○		
DOLBY PRO LOGIC IIx				○		○	○	○	○	○	○	○		
DOLBY PRO LOGIC II				○		○	○	○	○	○	○	○		
DTS NEO:6				○				○	○	○	○	○		
DOLBY DIGITAL	○*12	○	○	○					○	○	○	○		
DOLBY DIGITAL Plus	○*12	○	○	○					○	○	○	○		
DOLBY TrueHD	○*12	○	○	○					○	○	○	○		
DTS SURROUND	○*12	○	○	○					○	○	○	○		
DTS 96/24	○*12	○	○	○					○	○	○	○		
DTS-HD	○*12	○	○	○					○	○	○	○		
DTS Express	○*12	○		○					○	○	○	○		
MULTI CH STEREO									○	○	○	○		
ROCK ARENA									○*16	○	○	○		
JAZZ CLUB									○	○	○	○		
MONO MOVIE									○	○	○	○		
VIDEO GAME									○	○	○	○		
MATRIX									○	○	○	○		
VIRTUAL									○	○	○	○		

- *1 During playback in PURE DIRECT mode, the surround parameters are the same as in DIRECT mode.
- *4 Only when "Subwoofer Mode" is set to "LFE+Main" (page 61), sound is output from the subwoofer.
- *12 This item can be selected when "Surr.Parameter" – "PLIIz Height" (page 54) is set to "ON".
- *13 If "Speaker Config." – "F.Height" (page 61) is set to "None", this item cannot be selected.
- *14 This item can be selected when a Dolby Digital or DTS signal is played.
- *15 This item cannot be set when "Dynamic EQ®" (page 56) is set to "ON".
- *16 In this surround mode, bass is +6 dB, and treble is +4 dB. (Default)
- *17 For HD Audio whose sampling frequency of an input signal is more than 96 kHz, this sound parameter cannot be set.
- *18 This item cannot be set when "MultEQ® XT" (page 55) is set to "OFF" or "Manual".
- *19 This item cannot be set when "Dynamic EQ®" (page 56) is set to "OFF".
- *20 This item can be set when the input signal is analog, PCM 48 kHz or 44.1 kHz.

Types of input signals, and corresponding surround modes

This table shows the input signal that can be played in each surround mode. Check the audio signal of the input source then select the surround mode.

Symbols in the table

- This indicates the default surround mode.
- ⊙ This indicates the surround mode that is fixed when "AFDM" (page 54) is set to "ON".
- This indicates the selectable surround mode.

Surround mode (page 27)	NOTE	Input signal types and formats															
		ANALOG	PCM		DTS-HD		DTS					DOLBY		DOLBY DIGITAL			
			PCM (multi ch)	PCM (2ch)	DTS-HD Master Audio	DTS-HD High Resolution Audio	DTS EXPRESS	DTS ES DSCRT (With Flag)	DTS ES MTRX (With Flag)	DTS (5.1ch)	DTS 96/24	DOLBY TrueHD	DOLBY DIGITAL Plus	DOLBY DIGITAL EX (With Flag)	DOLBY DIGITAL EX (With no Flag)	DOLBY DIGITAL (5.1/5/4ch/3ch)	DOLBY DIGITAL (2ch)
DTS SURROUND																	
DTS-HD MSTR					●												
DTS-HD HI RES						●											
DTS ES DSCRT6.1	*1*3							●									
DTS ES MTRX6.1	*1*3								●	⊙							
DTS SURROUND									○	○							
DTS 96/24											●						
DTS (-HD) + PLIIx CINEMA	*2*3				○	○		○			○	○					
DTS (-HD) + PLIIx MUSIC	*1*3				○	○		○			○	○					
DTS (-HD) + PLIIz	*4				○	○		○			○	○					
DTS EXPRESS								●									
DTS (-HD) + NEO:6	*1*3				○	○		○			○	○					
DTS NEO:6 CINEMA		○		○													○
DTS NEO:6 MUSIC		○		○													○
DOLBY SURROUND																	
DOLBY TrueHD													●				
DOLBY DIGITAL+														●			
DOLBY DIGITAL EX	*1*3													○	○	○	
DOLBY (D+) (HD) +EX	*1*3												○	○			
DOLBY DIGITAL														○	●	●	
DOLBY (D) (D+) (HD) +PLIIx CINEMA	*2*3												○	○	●	○	
DOLBY (D) (D+) (HD) +PLIIx MUSIC	*1*3												○	○	○	○	
DOLBY (D) (D+) (HD) +PLIIz	*4												○	○	○	○	
DOLBY PRO LOGIC IIx CINEMA	*1*3	○		○													○
DOLBY PRO LOGIC IIx MUSIC	*1*3	○		○													○
DOLBY PRO LOGIC IIx GAME	*1*3	○		○													○
DOLBY PRO LOGIC IIz	*4	○		○													○
DOLBY PRO LOGIC II CINEMA		○		○													○
DOLBY PRO LOGIC II MUSIC		○		○													○
DOLBY PRO LOGIC II GAME		○		○													○
DOLBY PRO LOGIC		○		○													○

*1 If "Speaker Config." - "S.Back" (page 60) is set to "None", this surround mode cannot be selected.
 *2 If "Speaker Config." - "S.Back" (page 60) is set to "1sprkr" or "None", this surround mode cannot be selected.
 *3 This surround mode can be selected when "Amp Assign" (page 60) is set to "NORMAL".
 *4 If "Speaker Config." - "F.Height" (page 61) is set to "None", this surround mode cannot be selected.

Surround mode (page 27)	NOTE	Input signal types and formats															
		ANALOG	PCM		DTS-HD		DTS					DOLBY		DOLBY DIGITAL			
			PCM (multi ch)	PCM (2ch)	DTS-HD Master Audio	DTS-HD High Resolution Audio	DTS EXPRESS	DTS ES DSCRT (With Flag)	DTS ES MTRX (With Flag)	DTS (5.1ch)	DTS 96/24	DOLBY TrueHD	DOLBY DIGITAL Plus	DOLBY DIGITAL EX (With Flag)	DOLBY DIGITAL EX (With no Flag)	DOLBY DIGITAL (5.1/5/4ch/3ch)	DOLBY DIGITAL (2ch)
MULTI CH IN																	
MULTI CH IN			●														
MULTI CH IN + PLIIx CINEMA	*2*3		○														
MULTI CH IN + PLIIx MUSIC	*1*3		○														
MULTI CH IN + PLIIz	*4		○														
MULTI CH IN + Dolby EX	*1*3		○														
MULTI CH IN 7.1	*3		●◎ (7.1)														
DIRECT																	
DIRECT		○	○	○	○	○	○	○	○	○	○	○	○	○	○	○	○
PURE DIRECT																	
PURE DIRECT		○	○	○	○	○	○	○	○	○	○	○	○	○	○	○	○
DSP SIMULATION																	
MULTI CH STEREO		○	○	○	○	○	○	○	○	○	○	○	○	○	○	○	○
ROCK ARENA		○	○	○	○	○	○	○	○	○	○	○	○	○	○	○	○
JAZZ CLUB		○	○	○	○	○	○	○	○	○	○	○	○	○	○	○	○
MONO MOVIE		○	○	○	○	○	○	○	○	○	○	○	○	○	○	○	○
VIDEO GAME		○	○	○	○	○	○	○	○	○	○	○	○	○	○	○	○
MATRIX		○	○	○	○	○	○	○	○	○	○	○	○	○	○	○	○
VIRTUAL		○	○	○	○	○	○	○	○	○	○	○	○	○	○	○	○
STEREO																	
STEREO		●	○	●	○	○	○	○	○	○	○	○	○	○	○	○	○

- *1 If "Speaker Config." - "S.Back" ([page 60](#)) is set to "None", this surround mode cannot be selected.
- *2 If "Speaker Config." - "S.Back" ([page 60](#)) is set to "1spkr" or "None", this surround mode cannot be selected.
- *3 This surround mode can be selected when "Amp Assign" ([page 60](#)) is set to "NORMAL".
- *4 If "Speaker Config." - "F.Height" ([page 61](#)) is set to "None", this surround mode cannot be selected.

Relationship between video signals and monitor output

Input connector				Output connector			Menu displayed		
HDMI	COMPONENT	S-VIDEO	VIDEO	HDMI	COMPONENT	VIDEO	HDMI	COMPONENT	VIDEO
×	×	×	×	×	×	×	Only the menu is displayed	×	×
×	×	×	○	×	×	○ <VIDEO>	Only the menu is displayed	×	× (VIDEO)
×	×	○	×	×	×	○ <S-VIDEO>	Only the menu is displayed	×	× (S-VIDEO)
×	○	×	×	×	○ <COMPONENT>	×	Only the menu is displayed	× (COMPONENT)	×
×	○	×	○	×	○ <COMPONENT>	○ <VIDEO>	Only the menu is displayed	× (COMPONENT)	× (VIDEO)
×	○	○	×	×	○ <COMPONENT>	○ <S-VIDEO>	Only the menu is displayed	× (COMPONENT)	× (S-VIDEO)
○	×	×	×	○ <HDMI>	×	×	○ (HDMI)	×	×
○	×	×	○	○ <HDMI>	×	○ <VIDEO>	○ (HDMI)	×	× (VIDEO)
○	×	○	×	○ <HDMI>	×	○ <S-VIDEO>	○ (HDMI)	×	× (S-VIDEO)
○	○	×	×	○ <HDMI>	○ <COMPONENT>	×	○ (HDMI)	× (COMPONENT)	×
○	○	×	○	○ <HDMI>	○ <COMPONENT>	○ <VIDEO>	○ (HDMI)	× (COMPONENT)	× (VIDEO)
○	○	○	×	○ <HDMI>	○ <COMPONENT>	○ <S-VIDEO>	○ (HDMI)	× (COMPONENT)	× (S-VIDEO)

○ Video signal input present
 × No video signal input

○ < > The input signal between the < > marks is output.
 × No video signal output

○ () Superimposed on the picture indicated in ().
 × () Only the picture in () is output.

NOTE

- If you operate the menu while playing back 3D video content or computer's resolution (e.g. VGA), the playback video is replaced by the menu screen. The playback video is not displayed behind the menu screen.
- This unit does not show the status display while playing back 3D video content or computer's resolution (e.g. VGA).

Explanation of terms

A

Adobe RGB color, Adobe YCC601 color

Like “x.v.Color”, each of these color spaces defines a palette of available colors that is larger than the traditional RGB color model.

Audyssey Dynamic EQ®

Dynamic EQ® solves the problem of deteriorating sound quality as volume is decreased by taking into account human perception and room acoustics. Audyssey Dynamic EQ® works in tandem with Audyssey MultEQ® XT to provide well-balanced sound for every listener at any volume level.

Audyssey Dynamic Volume®

Dynamic Volume® solves the problem of large variations in volume level between television programs, commercials, and between the soft and loud passages of movies. Audyssey Dynamic EQ® is integrated into Dynamic Volume® so that as the playback volume is adjusted automatically, the perceived bass response, tonal balance, surround impression, and dialog clarity remain the same.

Audyssey MultEQ® XT

MultEQ® XT is a room equalization solution that calibrates any audio system so that it can achieve optimum performance for every listener in a large listening area. Based on several room measurements, MultEQ® XT calculates an equalization solution that corrects for both time and frequency response problems in the listening area and also performs a fully automated surround system setup.

Auto Lip Sync

If you connect the unit to a TV that supports the Auto Lip Sync function, it can automatically correct delay between the audio and video.

D

Deep Color

This technology allows expression of more number of colors than the conventional 8 bits and can reproduce colors close to natural ones without color streak.

Dolby Digital

Dolby Digital is a multi-channel digital signal format developed by Dolby Laboratories.

A total of 5.1 channels are played: 3 front channels (“FL”, “FR” and “C”), 2 surround channels (“SL” and “SR”) and the “LFE” channel for low frequencies.

Because of this, there is no crosstalk between channels and a realistic sound field with a “three-dimensional” feeling (sense of distance, movement and positioning) is achieved.

A realistic, powerful sense of presence is achieved when playing movie sources in AV rooms as well.

Dolby Digital EX

Dolby Digital EX is a 6.1-channel surround format proposed by Dolby Laboratories that allows users to enjoy in their homes the “DOLBY DIGITAL SURROUND EX” audio format jointly developed by Dolby Laboratories and Lucas Films.

The 6.1 channels of sound, including surround back channels, provide improved sound positioning and expression of space.

Dolby Digital Plus

Dolby Digital Plus is an improved Dolby Digital signal format that is compatible with up to 7.1 channels of discrete digital sound and also improves sound quality thanks to extra data bit rate performance. It is upwardly compatible with conventional Dolby Digital, so it offers greater flexibility in response to the source signal and the conditions of the playback device.

Dolby Pro Logic II

Dolby Pro Logic II is a matrix decoding technology developed by Dolby Laboratories.

Regular music such as that on CDs is encoded into 5 channels to achieve an excellent surround effect. The surround channel signals are converted into stereo and full band signals (with a frequency response of 20 Hz to 20 kHz or greater) to create a “three-dimensional” sound image offering a rich sense of presence for all stereo sources.

Dolby Pro Logic IIx

Dolby Pro Logic IIx is a further improved version of the Dolby Pro Logic II matrix decoding technology. Audio signals recorded in 2 channels are decoded to achieve a natural sound with up to 7.1 channels. There are three modes: “Music” suited for playing music, “Cinema” suited for playing movies, and “Game” which is optimized for playing games.

Dolby Pro Logic IIz

Dolby Pro Logic IIz introduces a new dimension to Home Entertainment through the addition of a pair of front height channels. Compatible with stereo, 5.1-channel and 7.1-channel content, Dolby Pro Logic IIz provides enhanced spaciousness, depth and dimension to movies, concert video and video game playback while maintaining the full integrity of the source mix.

Dolby Pro Logic IIz identifies and decodes spatial cues that occur naturally in all content, directing this information to the front height channels, complementing the performance of left and right surround sound speakers. Content that is encoded with Dolby Pro Logic IIz height channel information can be even more revealing, with perceptually discrete height channel information bringing an exciting new dimension to home entertainment.

Dolby Pro Logic IIz, with front height channels is also an ideal alternative for households that cannot support the placement of back surround speakers of a typical 7.1-channel system but may have bookshelf space available to support the addition of height speakers.

Dolby TrueHD

Dolby TrueHD is a high definition audio technology developed by Dolby Laboratories, using lossless coding technology to faithfully reproduce the sound of the studio master.

This format provides the facility to support up to 8 audio channels with a sampling frequency of 96kHz/24bit resolution and up to 6 audio channels with a sampling frequency of 192kHz/24bit resolution. Dolby TrueHD is adopted for applications that put very high importance on sound quality.

Downmix

This function converts the number of channels of surround audio to less number of channels and plays back.

DTS

This is an abbreviation of Digital Theater System, which is a digital audio system developed by DTS. When playing back audio by connecting this system with a device such as DTS amplifier, accurate sound field position and realistic sound effect as if you are in a movie theater can be obtained.

DTS 96/24

DTS 96/24 is a digital audio format enabling high sound quality playback in 5.1 channels with a sampling frequency of 96 kHz and 24 bit quantization on DVD-Video.

DTS Digital Surround

DTS Digital Surround is the standard digital surround format of DTS, Inc., compatible with a sampling frequency of 44.1 or 48 kHz and up to 5.1 channels of digital discrete surround sound.

DTS-ES™ Discrete 6.1

DTS-ES™ Discrete 6.1 is a 6.1-channel discrete digital audio format adding a surround back (SB) channel to the DTS digital surround sound.

Decoding of conventional 5.1-channel audio signals is also possible according to the decoder.

DTS-ES™ Matrix 6.1

DTS-ES™ Matrix 6.1 is a 6.1-channel discrete digital audio format inserting a surround back (SB) channel to the DTS digital surround sound through matrix encoding. Decoding of conventional 5.1-channel audio signals is also possible according to the decoder.

DTS Express

DTS Express is an audio format supporting low bit rates (max. 5.1 channels, 24 to 256 kbps).

DTS-HD

This audio technology provides higher sound quality and enhanced functionality than the conventional DTS and is adopted as an optional audio for Blu-ray Disc. This technology supports multi-channel, high data transfer speed, high sampling frequency, and lossless audio playback. Maximum 7.1-channels are supported in Blu-ray Disc.

DTS-HD High Resolution Audio

DTS-HD High Resolution Audio is an improved version of the conventional DTS, DTS-ES and DTS 96/24 signals formats, compatible with sampling frequencies of 96 or 48 kHz and up to 7.1 channels of discrete digital sound. High data bit rate performance provides high quality sound. This format is fully compatible with conventional products, including conventional DTS digital surround 5.1-channel data.

DTS-HD Master Audio

DTS-HD Master Audio is a lossless audio format created by Digital Theater System (DTS). This format provides the facility to support up to 8 audio channels with a sampling frequency of 96kHz/24bit resolution and up to 6 audio channels with a sampling frequency of 192kHz/24bit resolution. It is fully compatible with conventional products, including conventional DTS digital surround 5.1-channel data.

DTS NEO:6™ Surround

DTS NEO:6™ is a matrix decoding technology for achieving 6.1-channel surround playback with 2-channel sources. It includes “DTS NEO:6 Cinema” suited for playing movies and “DTS NEO:6 Music” suited for playing music.

Dynamic range

The difference between the maximum undistorted sound level and the minimum discernible level above the noise emitted by the device.

H**HDCP**

When transmitting digital signals between devices, this copyright protection technology encrypts the signals to prevent content from being copied without authorization.

HDMI

This is an abbreviation of High-Definition Multimedia Interface, which is an AV digital interface that can be connected to a TV or amplifier. Video signal and audio signal can be connected using 1 cable.

L**LFE**

This is an abbreviation of Low Frequency Effect, which is an output channel that emphasizes low frequency effect sound. Surround audio is intensified by outputting 20 Hz to 120 Hz deep bass.

M**MAIN ZONE**

The room where this unit is placed is called the MAIN ZONE .

MP3 (MPEG Audio Layer-3)

This is an internationally standardized audio data compression scheme, using the “MPEG-1” video compression standard. It compresses the data volume to about one eleventh its original size while maintaining sound quality equivalent to a music CD.

MPEG (Moving Picture Experts Group), MPEG-2, MPEG-4

These are the names for digital compression format standards used for the encoding of video and audio. Video standards include “MPEG-1 Video”, “MPEG-2 Video”, “MPEG-4 Visual”, “MPEG-4 AVC”. Audio standards include “MPEG-1 Audio”, “MPEG-2 Audio”, “MPEG-4 AAC”.

P**Progressive (sequential scanning)**

This is a scanning system of video signal that displays 1 frame of video as one image. Compared to the interlace system, this system provides images with less flickering and bleeding.

Protection Circuit

This is a function to prevent damage to devices within the power supply when an abnormality such as an overload, excess voltage occurs or temperature for any reason.

In this unit, the power indicator blinks and the unit enters standby mode when an abnormality occurs.

S**Sampling frequency**

Sampling involves taking a reading of a sound wave (analog signal) at regular intervals and expressing the height of the wave at each reading in digitized format (producing a digital signal).

The number of readings taken in one second is called the “sampling frequency”. The larger the value, the closer the reproduced sound is to the original.

Speaker impedance

This is an AC resistance value, indicated in Ω (ohms). Greater power can be obtained with this value smaller.

sYCC601 color

Like “x.v.Color”, each of these color spaces defines a palette of available colors that is larger than the traditional RGB color model.

X**x.v.Color**

This function lets HDTVs display colors more accurately. It enables display with natural, vivid colors. “x.v.Color” is a Sony registered trademark.

Z**ZONE2**

This unit can operate in a room other than the room where this unit is placed (MAIN ZONE) (ZONE2 playback). The room for ZONE2 playback is called ZONE2.

Troubleshooting

If a problem should arise, first check the following:

1. Are the connections correct?



2. Is the set being operated as described in the owner's manual?

3. Are the other devices operating properly?

If this unit does not operate properly, check the items listed in the table below. Should the problem persist, there may be a malfunction.

In this case, disconnect the power immediately and contact your store of purchase.



[General]

Symptom	Cause/Solution	Page
Power does not turn on.	<ul style="list-style-type: none"> Check whether the power plug is correctly inserted into the power outlet. The protection circuit is active. Disconnect the power plug from the electric outlet, wait 5 to 10 seconds and then insert it back into the outlet. 	 5 93
Display is off.	<ul style="list-style-type: none"> Set "Dimmer" on the menu to something other than "OFF". 	66
The power indicator is blinking red in intervals of approximately 2 seconds.	<ul style="list-style-type: none"> The temperature inside the unit has risen. Please turn off power once, and re-apply the power after the temperature has fallen sufficiently. Please re-install this unit in a place having good ventilation. 	– –
The power indicator is blinking red in intervals of approximately 0.5 seconds.	<ul style="list-style-type: none"> Please use speakers which have the specified impedance. The speaker cable has shorted (is touching). Firmly twist the core wire in the speaker cable, and then re-connect it to the speaker terminal. 	 6 , 34  6
After turning on the power, the power indicator is blinking red in intervals of approximately 0.5 seconds.	<ul style="list-style-type: none"> This unit amplifier circuit has failed. Turn off the power and please contact the DENON service adviser. 	–
Set does not operate properly.	<ul style="list-style-type: none"> Reset the microprocessor. 	96

[HDMI]

Symptom	Cause/Solution	Page
No audio is output with HDMI connection.	<ul style="list-style-type: none"> Check the connection of the HDMI connectors. When outputting HDMI audio from the speakers, set "HDMI Audio Out" on the menu to "AMP". When outputting HDMI audio from a TV, set "HDMI Audio Out" on the menu to "TV". 	7 63 63
No video is output with HDMI connection.	<ul style="list-style-type: none"> Check the connection of the HDMI connectors. Set the input source to match the connected HDMI connector. Check whether the TV is compatible with copyright protection (HDCP). If connected to a device not compatible with HDCP, video will not be output correctly. 	7 7 , 20 6
When the following operations are performed on devices compatible with HDMI control, the same operations occur on this unit. <ul style="list-style-type: none"> Power ON/OFF Switching audio output devices Adjust volume Switch input source 	<ul style="list-style-type: none"> Set "HDMI Control" in the menu to "OFF". <p>Furthermore, if you do not want to link the power off operation with devices compatible with HDMI control, set "P.Off Control" in the menu to "OFF".</p>	41 , 63

[Video]

Symptom	Cause/Solution	Page
No picture appears.	<ul style="list-style-type: none"> Check the TV connection. Set the TV input correctly. 	 3  3

[Audio]

Symptom	Cause/Solution	Page
Audio is not output.	<ul style="list-style-type: none"> • Check the connections for all devices. • Check the speaker connections and configurations. • Check whether the audio device power is turned on. • Adjust the master volume. • Cancel the mute mode. • Select a suitable input source. • Select a suitable input mode. • Disconnect the headphones. No sound is output from the speakers when headphones are connected. 	3 , 7 , 8 , 9 , 10 , 11 , 12 6 , 34 , 35 , 36 , 37 , 38 , 39 – 21 , 45 21 , 45 20 , 45 72 81
No sound is produced from surround speaker.	<ul style="list-style-type: none"> • Check if the surround speakers are connected to the SURROUND terminals. 	–
No sound is produced from surround back speaker.	<ul style="list-style-type: none"> • Check if “Amp Assign” is set appropriately in order to output audio from the surround back speakers. • Set “Speaker Config.” – “S.Back” on the menu to something other than “None”. • Set “Surr.Parameter” – “S.Back” on the menu to something other than “OFF”. • Set the surround mode to something other than “STEREO” and “VIRTUAL”. 	60 60 54 27
No sound is produced from front height speaker.	<ul style="list-style-type: none"> • Set “Surr.Parameter” – “PLIIz Height” on the menu to “ON”. • Check if “Amp Assign” is set appropriately in order to output audio from the front height speakers. • Set “Speaker Config.” – “F.Height” on the menu to something other than “None”. 	54 60 61
No sound is produced from subwoofer.	<ul style="list-style-type: none"> • Check the subwoofer connections. • Turn on the subwoofer’s power. • Set “Speaker Config.” – “Subwoofer” on the menu to “Yes”. • If “Front” and “Center” for “Speaker Config.” are set to “Large”, and “Subwoofer Mode” is set to “LFE”, no sound may be output from the subwoofers, depending on the input signal or selected surround mode. 	6 , 34 , 35 , 36 , 37 , 38 – 60 60 , 61
DTS sound is not output.	<ul style="list-style-type: none"> • Set “Decode Mode” on the menu to “Auto” or “DTS”. 	72

Symptom	Cause/Solution	Page
Dolby TrueHD, DTS-HD, Dolby Digital Plus audio is not output.	<ul style="list-style-type: none"> • Make HDMI connections. 	7
Dolby PLII mode or DTS NEO:6 mode cannot be selected.	<ul style="list-style-type: none"> • Check that “Speaker Config.” – “Center” or “Surround” is set to other than “None”. If the speaker system is 2.0/2.1ch, this surround mode cannot be selected. • When headphones are used, Dolby PLII or DTS NEO:6 cannot be selected. 	60 –
MultEQ [®] XT, Dynamic EQ [®] and Dynamic Volume [®] cannot be selected.	<ul style="list-style-type: none"> • Switch the surround mode to other than “DIRECT” or “PURE DIRECT”. • When headphones are used, MultEQ[®] XT, Dynamic EQ[®] and Dynamic Volume[®] cannot be selected. 	27 –
Dynamic EQ [®] and Dynamic Volume [®] cannot be selected.	<ul style="list-style-type: none"> • Run Audyssey[®] Auto Setup. 	13 , 39
RESTORER cannot be selected.	<ul style="list-style-type: none"> • Check that an analog signal or PCM signal (fs=44.1/48 kHz) is input. For playback of multichannel signals such as Dolby Digital or DTS surround, RESTORER cannot be used. • Switch the surround mode to other than “DIRECT” or “PURE DIRECT”. 	57 27

[Radio]

Symptom	Cause/Solution	Page
Reception fails, or there is a lot of noise or distortion.	<ul style="list-style-type: none"> • Change the antenna orientation or position. • Separate the AM loop antenna from the unit. • Use an FM outdoor antenna. • Separate the antenna from other connection cables. 	11 11 11 11

[Control dock for iPod]

Symptom	Cause/Solution	Page
iPod cannot be played.	<ul style="list-style-type: none"> • Check the iPod connections. • Insert the AC adaptor of the iPod control dock into the power outlet. • Switch the input source to “DOCK”. 	10 – 20

[iPod]

Symptom	Cause/Solution	Page
The file names are not displayed properly ("...", etc.).	<ul style="list-style-type: none">Characters that cannot be displayed are used. This is not a malfunction. On this unit, characters that cannot be displayed are replaced with a "." (period).	-

[Remote Control Unit]

Symptom	Cause/Solution	Page
The set cannot be operated with the remote control unit.	<ul style="list-style-type: none">Batteries are worn out. Replace with new batteries.	85
	<ul style="list-style-type: none">Operate the remote control unit within a distance of about 23 ft/7 m from this unit and at an angle of within 30°.	85
	<ul style="list-style-type: none">Remove any obstacle between this unit and the remote control unit.	85
	<ul style="list-style-type: none">Insert the batteries in the proper direction, checking the ⊕ and ⊖ marks.	85
	<ul style="list-style-type: none">The set's remote control sensor is exposed to strong light (direct sunlight, inverter type fluorescent bulb light, etc.). Move the set to a place in which the remote control sensor will not be exposed to strong light.	85
	<ul style="list-style-type: none">The ZONE SELECT setting is not correct. Press ZONE SELECT to select the zone to operate.	74
	<ul style="list-style-type: none">The operation mode does not match the settings of the device to operate. Check the operation mode.	74

Resetting the microprocessor

Perform this procedure if the display is abnormal or if operations cannot be performed. When the microprocessor is reset, all the settings are reset to their default values.

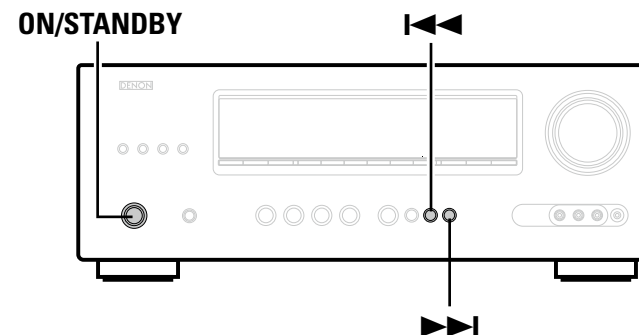

1 Turn off the power using **ON/STANDBY**.

2 Press **ON/STANDBY** while simultaneously pressing **◀◀** and **▶▶**.

3 Once the display starts flashing at intervals of about 1 second, release the two buttons.



If in step 3 the display does not flash at intervals of about 1 second, start over from step 1.

Specifications

□ Audio section

• Power amplifier

Rated output:

Front:
90 W + 90 W (8 Ω, 20 Hz – 20 kHz with 0.08 % T.H.D.)
125 W + 125 W (6 Ω, 1 kHz with 0.7 % T.H.D.)

Center:

90 W (8 Ω, 20 Hz – 20 kHz with 0.08 % T.H.D.)
125 W (6 Ω, 1 kHz with 0.7 % T.H.D.)

Surround:

90 W + 90 W (8 Ω, 20 Hz – 20 kHz with 0.08 % T.H.D.)
125 W + 125 W (6 Ω, 1 kHz with 0.7 % T.H.D.)

Surround back:

90 W + 90 W (8 Ω, 20 Hz – 20 kHz with 0.08 % T.H.D.)
125 W + 125 W (6 Ω, 1 kHz with 0.7 % T.H.D.)

6 – 16 Ω

Output connectors:

• Analog

Input sensitivity/Input impedance:

200 mV/47 kΩ

Frequency response:

10 Hz – 100 kHz — +1, –3 dB (DIRECT mode)

S/N:

100 dB (IHF–A weighted, DIRECT mode)

□ Video section

• Standard video connectors

Input/output level and impedance:

1 V_{p-p}, 75 Ω

Frequency response:

5 Hz – 10 MHz — 0, –3 dB

• Color component video connector

Input/output level and impedance:

Y (brightness) signal — 1 V_{p-p}, 75 Ω

P_B / C_B signal — 0.7 V_{p-p}, 75 Ω

P_R / C_R signal — 0.7 V_{p-p}, 75 Ω

Frequency response:

5 Hz – 60 MHz — 0, –3 dB

□ Tuner section

Receiving Range:

(Note: μV at 75 Ω, 0 dBf = 1 × 10⁻¹⁵ W)

87.5 MHz – 107.9 MHz

520 kHz – 1710 kHz

Usable Sensitivity:

1.2 μV (12.8 dBf)

18 μV

50 dB Quieting Sensitivity:

MONO 2.8 μV (20.2 dBf)

S/N:

MONO 70 dB (IHF–A weighted, DIRECT mode)

STEREO 67 dB (IHF–A weighted, DIRECT mode)

Total harmonic Distortion (at 1 kHz):

MONO 0.7 %

STEREO 1.0 %

□ General

Power supply:

AC 120 V, 60 Hz

Power consumption:

460 W

0.1 W (Standby)

3 W (CEC standby)

For purposes of improvement, specifications and design are subject to change without notice.

Index

Numerics

2.1-channel	37
2ch Direct/Stereo	64
3D	6
6.1-channel	33, 36
7.1-channel	32, 33, 34, 35

A

Accessories	1
Adjust Channel	57
Adjusting the master volume	21
Adobe RGB color / Adobe YCC601 color	92
AFDM	54
AM loop antenna	11
Amp Assign	60
ARC	6
Audio Adjust	52
Audio Delay	57
Audio Setup	64
Audyssey® Auto Setup	13, 39
Audyssey Dynamic EQ®	56, 92
Audyssey Dynamic Volume®	56, 92
Audyssey MultEQ® XT	55, 92
Audyssey Settings	55
Auto Lip Sync	63, 92
Auto Preset	69
Auto Setup	13, 39
Auto Surround	64

B

Bass	55
Bass Setting	61
Bi-amp	38
Browse mode	22

C

Cable	
Audio cable	9, 10, 11
Coaxial digital cable	9
Component video cable	8, 9
HDMI cable	7
Optical cable	8
Video cable	8, 9, 10
Channel Level	43, 62
Characters	50
C.Image	53
Cinema EQ	53
Condensation	2

Connection	
Antenna	11
Blu-ray Disc player	7, 9
Cable TV	9
CD player	11
Control dock for iPod	10
Digital camcorder	7, 10
DVD player	7, 9
External control device	12
Game console	7
HDMI	6
Satellite tuner	9
Set-top box	7, 9
Speaker	34
TV	7, 8
Content Type	6
Crossover Freq.	62
Curve Copy	57
C.Width	53

D

D.Comp	53
Decode Mode	72
Deep Color	6, 92
Delay Time	53
Dimension	53
Dimmer	66
Display	82
Distance	61
Dolby	
Dolby Digital	92
Dolby Digital EX	92
Dolby Digital Plus	92
Dolby Pro Logic II	92
Dolby Pro Logic IIx	92
Dolby Pro Logic IIz	32, 92
Dolby TrueHD	92
Downmix	92
DRC	53
DTS	92
DTS 96/24	92
DTS Digital Surround	92
DTS-ES Discrete 6.1	92
DTS-ES Matrix 6.1	92
DTS Express	92
DTS-HD	92
DTS-HD High Resolution Audio	92
DTS-HD Master Audio	93
DTS NEO:6™ Surround	93
Dynamic EQ®	56
Dynamic range	93
Dynamic Volume®	56

E

Effect Level	53
EQ Customize	64
Error messages (Auto Setup)	18

F

Fader function	43
F.Height	61
FM/AM	25
FM indoor antenna	11
Front A/B (connection)	33, 37
Front height speaker	33, 35
Front Panel	81
Front Sp Setup	62

G

GUI	66
-----	----

H

HDCP	6, 93
HDMI	6, 93
HDMI 1.4a	6
HDMI Audio Out	63
HDMI Control	41, 63
HDMI Setup	63
Headphones	81
Height Gain	54

I

Information	58
Audio Signal	58
Auto Surround	58
HDMI Information	58
Preset Channel	58
Quick Select	58
Status	58
Input Assign	70
Input Mode	72
Input Setup	68
Input signal	89
Inputting characters	50
iPod PLAY	24

L

Language	67
Lch Level	65
LFE	53, 93
Listening mode	27
Listening position	13

M

MAIN ZONE	93
Manual EQ	57
Master volume	66
Menu map	47
Mode	53
MP3	93
MPEG	93
MultEQ® XT	55
Mute Level	65

O

Option Setup	65
Dimmer	66
GUI	66
Quick Sel.Name	66
Remote Setup Guide	66
Setup Lock	66
Source Delete	65
Volume Control	65
Zone Rename	66

P

Panorama	53
Parameter Check	19
Playback	
Blu-ray Disc player	21
CD player	21
Direct	30
DVD player	21
FM/AM	25
iPod (Control dock for iPod)	22
Pure direct	30
Stereo	30
ZONE2	45
Playback Mode (Control dock for iPod)	73
PLIIz Height	54
P.Off Control	63
Power On Level	65
Preset codes	66, 75
Preset Name	69
Preset Skip	69
Presetting radio stations	25
Progressive	93
Protection circuit	93

Q

Quick select	44, 46
Quick Sel.Name	66

👉 R	
Rich Level	65
Rear panel	83
Reference Offset	56
Remote control setting	14, 39
Remote control unit	74, 84
Inserting the batteries	85
Operating AV devices	74
Operating devices	77
Registering Preset Codes	75
Remote mode	22
Remote Setup Guide	66
Rename	72
Repeat	73
Resetting the microprocessor	96
RESTORER	57
Room Size	53

👉 S	
Sampling frequency	93
S.Back	54, 60
Screensaver	66
Selecting the input source	20
Setup Lock	66
Shuffle	73
Sleep timer	42, 46
Source Delete	65
Source Level	72
Speaker	
Connect	34
Install	32
Set up	13, 39
Speaker Config.	60
Speaker impedance	93
Speaker Setup	60
Standby Source	63
Subwoofer	54
Subwoofer setting	14
Surround back speaker	32, 33, 34, 36
Surround mode	27, 87
Surr.Parameter	53
sYCC601 color	93
System Setup	59

👉 T	
Tone	55
Tone Control	55
Trademark	86
Treble	55
Troubleshooting	94
Turning off the sound temporarily	21

👉 V	
Video	71
Video Mode	71
Video Select	71
Volume Control	65
Volume Display	65
Volume Limit	65

👉 X	
x.v.Color	6, 93

👉 Z	
ZONE2	45, 82, 93
ZONE2 Setup	65
Zone Rename	66

Dimensions

Unit : in. (mm)

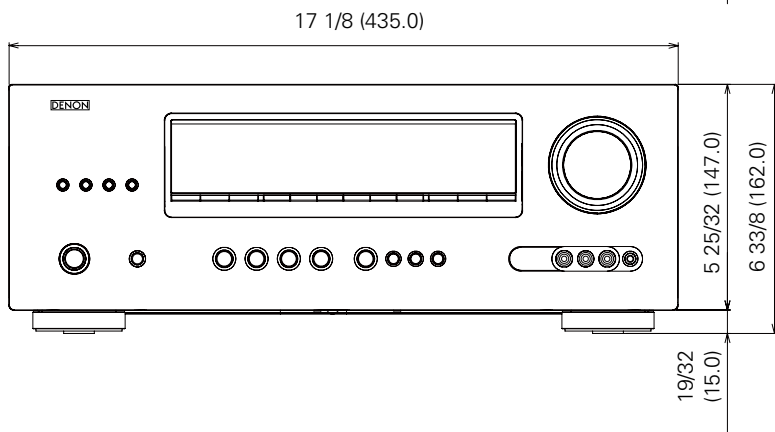
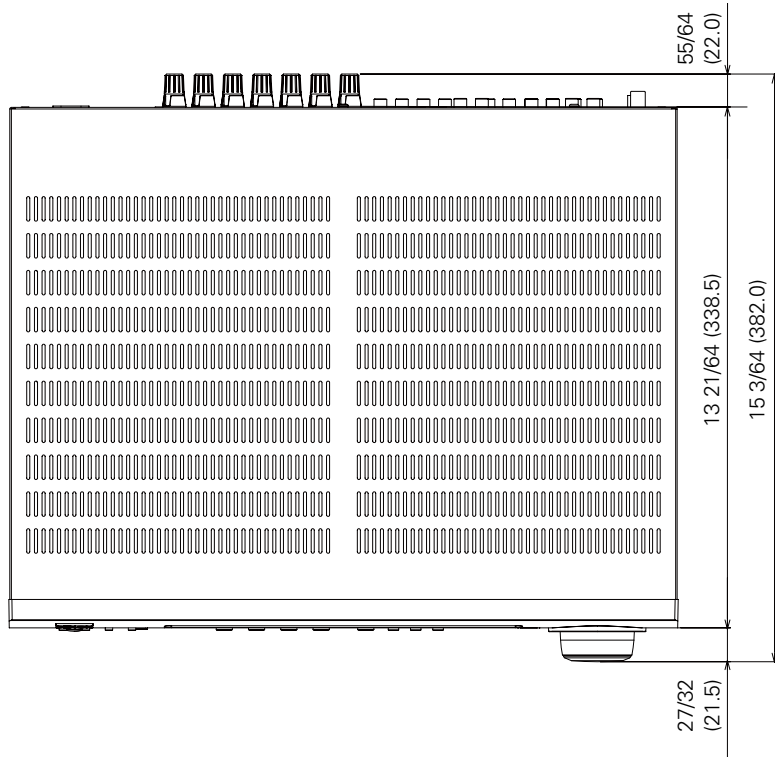

Weight : 22 lbs 7.8 oz (10.2 kg)

